



KIRIMCI
METAL



2026 KATALOG

KORKULUK SİSTEMLERİ - SAC ÜRÜNLER - FERFORJE - LAZER KESİM
FENCE SYSTEMS - SHEET PRODUCTS - WROUGHT IRON - LASER-CUT

www.kirimcimental.com



KIRIMCI METAL FORM SAN. TİC. A.Ş., demir ve makine sektöründe 30 yıllık deneyime sahip kurucumuz Nazmi Kırımıcı tarafından 2014 yılında Bursa'da kurulmuştur. Kuruluşundan bu yana faaliyetlerinde kalite, güvenilirlik ve müşteri memnuniyetine öncelik vermektedir.

Geniş ve modern makine parkurumuzla lazer kesim sac, desenli sac, çelik kapı panelleri, genişletilmiş metal, delikli sac, nervürlü boru, sac motifler, ferforje ürünler ve kapı elemanları üretmekteyiz. ISO 9001 Kalite Yönetim Sistemi Sertifikasına sahip firmamız, "Yüksek Kalite – Hızlı Teslimat – Güvenilir Hizmet" anlayışıyla kısa sürede önemli bir büyüme kaydetmiştir.

Bugün, güçlü yerel bayi ağımızın yanı sıra, yaklaşık 40 ülkeye ihracat yaparak ürünlerimizi küresel pazara sunmaktayız.

10.000 m² kapalı üretim tesisimizde; deneyimli tasarım ve AR-GE ekiplerimizle ürün yelpazemizi sürekli geliştirerek ve yüksek üretim kapasitemiz ve gelişmiş teknolojik altyapımız sayesinde hem yerli hem de uluslararası müşterilerimize hızlı ve güvenilir çözümler sunuyoruz.

Avrupa standartlarındaki üretim yaklaşımımız doğrultusunda, sürekli gelişen üretim teknolojilerimizle müşterilerimize rekabetçi fiyatlarla yüksek kalite sunmaya devam ediyoruz.



KIRIMCI METAL FORM SAN. TİC. A.Ş. was founded in Bursa in 2014 by Nazmi Kırımıcı, a founder with 30 years of experience in the iron and machinery sector. Since its inception, it has prioritized quality, reliability, and customer satisfaction in its operations.

With our extensive and modern machinery park, we produce laser-cut sheet metal, patterned sheet metal, steel door panels, expanded metal, perforated sheet metal, ribbed pipe, sheet metal motifs, wrought iron products, and door elements. Our company, which holds ISO 9001 Quality Management System Certification, has achieved significant growth in a short time with its understanding of "High Quality – Fast Delivery – Reliable Service".

Today, in addition to our strong local dealer network, we offer our products to the global market by exporting to approximately 40 countries.

In our 10,000 m² enclosed production facility, we continuously improve our product range with our experienced design and R&D teams, and thanks to our high production capacity and advanced technological infrastructure, we provide fast and reliable solutions to both domestic and international customers.

In line with our European-standard production approach, we continue to offer our customers high quality at competitive prices through our constantly evolving production technologies.

Korkuluk Sistemleri
Fence Systems

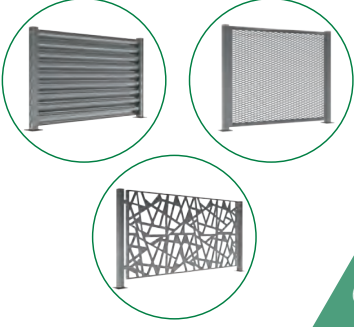

6-19

Genişletilmiş Metaller
Expanded Metal Sheets

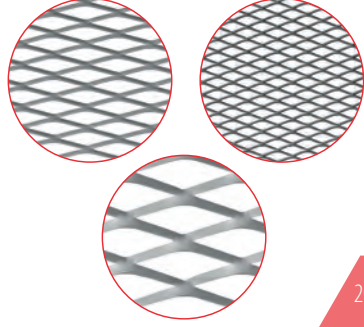

20-25

Delikli Saclar
Perforated Sheets

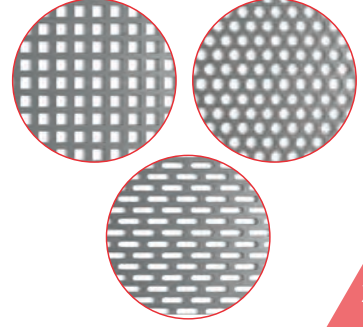

26-27

Desenli Saclar
Patterned Sheets

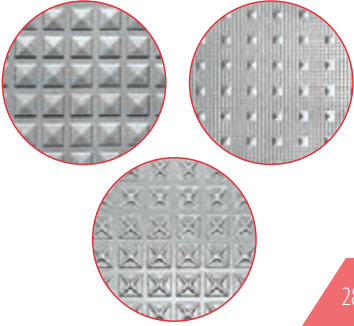

28-30

Çelik Kapı Sacları
Metal Door Sheets

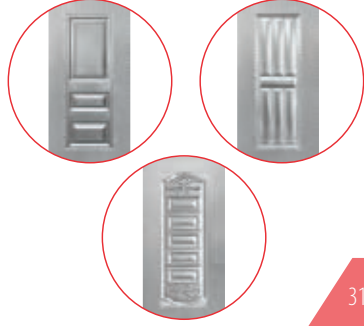

31-55

Dekoratif Lamalar-Profiller-Küpeşterler
Decorative Flat Bars-Profiles-Handrails

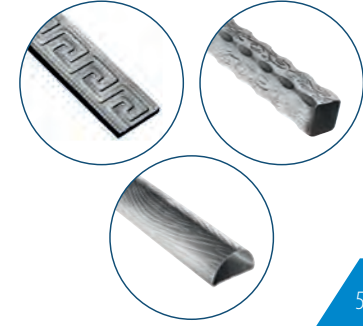

56-58

Boğumlu-Nervürlü-Konik Borular
Gnarled-Ribbed-Conical Pipes



59-64

Küreler-Kabaralar-Plastik Kapaklar
Spheres-Rivets-Plastic Lids



65

Boru ve Profil Kapakları-Flanşlar-Dövme Rozetler
Pipe and Profile Lids-Flanges-Forged Rosettes

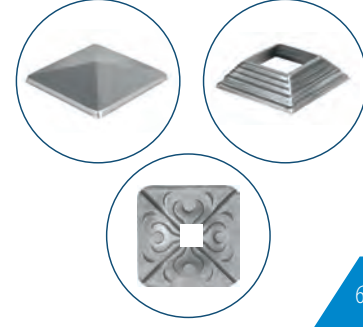

66-70

Sac Rozetler-Yapraklar-Motifler
Sheet Rosettes-Leaves-Motifs



71-81

Sac Göbekler-Bordürler
Sheet Centers-Frames

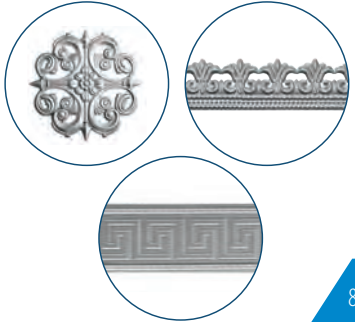

82-86

Kelepçeler-Boyalar
Collar Bars-Paints

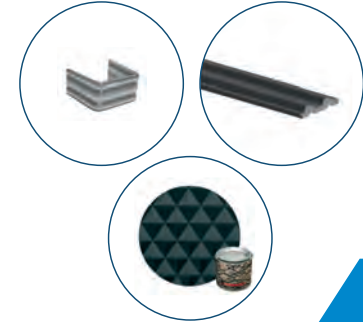

87

Halkalar-Şişimeler-Mızraklar
Rings-Hot Forged Pieces-Spears



88-89

Dekoratif Mentşeseler-Kapı Aynaları-Kapı Kolları
Decorative Hinges-Door Lock Plates-Door Handles



90-96

Kapı Aksesuarları
Door Accessories



97-102

C ve S Motifler-Kozalaklar ve Kozalaklı Çubuklar
C and S Scrolls-Baskets and Basket Bars



103-105

Cumbalar-Baba Demirler
Balustrades-Begining Bars

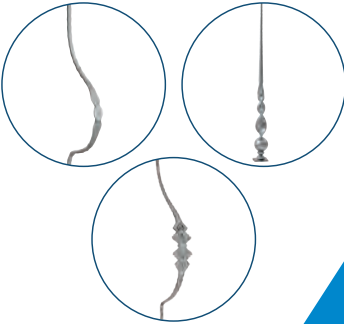

106

Motifli Çubuklar
Balustrades

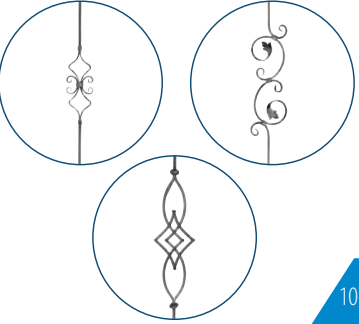

107-110

Ekonomik Ferforje Ürünler
Economic Wrought Iron Products

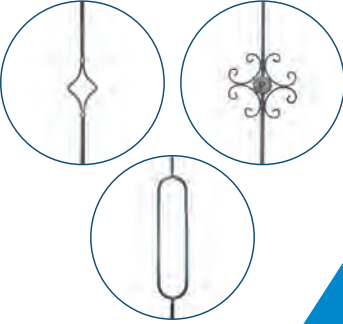

111

Ferforje Paneller
Wrought Iron Motifs



112-119

Flütler-Bağlantı Elemanları
Flute Bars-Connection Pieces

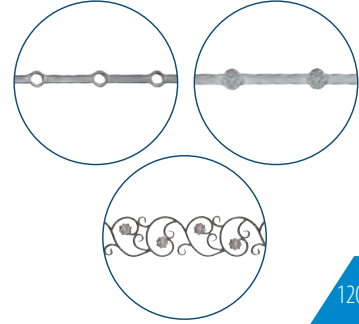

120-121

Döküm Ürünler
Cast Products



122-124

Lazer Kesimli Saclar
Laser-Cut Sheets

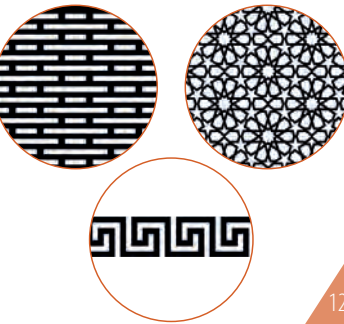

125-145

Index-Uygulama Görselleri
Index-Application Images



146-161

NEMRUT
panjur çit/shutter fence

PROFİL
galvanizli profil
flaş kaynaklı
POST
galvanized profile
welded flange

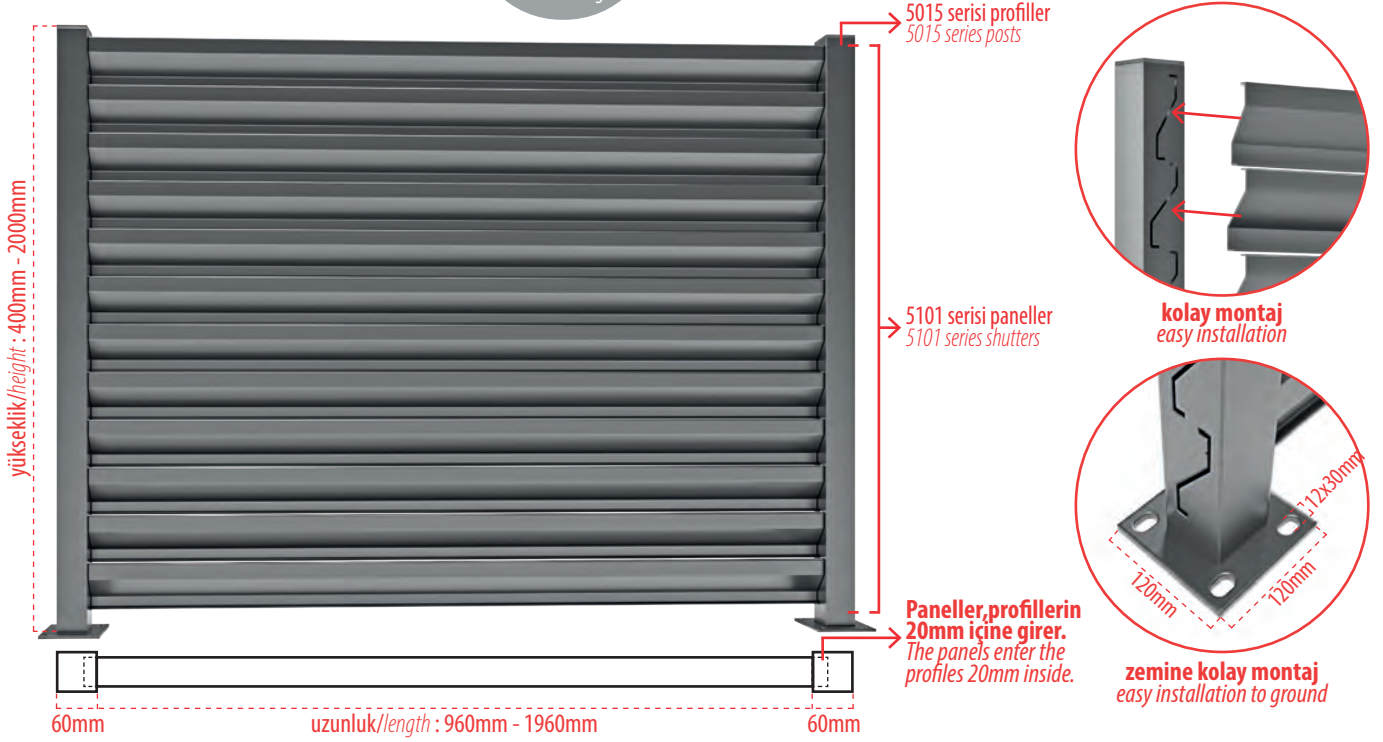

Profil Post			
Görsel Image	Kod Code	Yükseklik Height	Kullanılacak Panel Sayısı Pieces of Panel
	5015-400	400 mm	4
	5015-500	500 mm	5
	5015-600	600 mm	6
	5015-750	750 mm	8
	5015-850	850 mm	9
	5015-940	940 mm	10
	5015-1000	1000 mm	11
	5015-1200	1200 mm	13
	5015-1480	1480 mm	16
	5015-1750	1750 mm	19
	5015-2000	2000 mm	22

***Standart profiller; 1.5mm kalınlıktaki 60x60mm GALVANİZLİ profilden üretilmektedir.
*** Standard profiles are produced from 60x60mm GALVANIZED profile with 1.5 mm thickness.

***Her profil; kendinden kaynaklı 120x120x4mm flaşıyla ve 60x60mm plastik kapağıyla birlikte takım halindedir.
***Each post is supplied as a set with its own welded 120x120x4mm flange and 60x60mm plastic lid.

Panel Shutter		
Görsel Image	Kod Code	Uzunluk Length
	5101-1000	1000 mm
	5101-1200	1200 mm
	5101-1500	1500 mm
	5101-2000	2000 mm

***Paneller; 1mm kalınlıktaki galvanizli sacdan üretilmektedir.
***Shutters are produced from 1mm thickness galvanized sheet metal.

***Paneller, profillerin 20mm içine girer.
***The shutters enter the profiles 20mm inside.

***Paneller ve profiller isteğe bağlı olarak, boyalı veya boyasız olarak üretilmektedir.
***Shutters and posts is produced in painted or unpainted versions, upon request.

***Uygulama Örneği: 100cm yüksekliğindeki Nemrut model uygulaması için;
5015-1000 kodlu profil + 11 adet 5101 serisi panjur panel kullanılmaktadır.
Panjur panellerinde 100cm, 120cm, 150cm ve 200cm uzunluk alternatifleri bulunmaktadır.
***Application Example: 100cm height Nemrut model application;
Profile code 5015-1000 + 11 pieces of 5101 series shutter panels are used.
Shutter panels are available in 100cm, 120cm, 150cm and 200cm length alternatives.

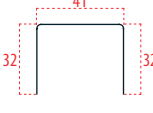
Panjur Kapı Sabitleme U Kanal Profili Shutter Door Fitting U Profile			
Görsel Image	Kod Code	Ölçü Dimension	Uzunluk Length
	5005-1500		1500 mm
	5005-2000		2000 mm
	5005-2500		2500 mm
<p>***Panjur kapıların çerçeve ve sabitleme noktalarında kullanılan U Kanal Profil, kapının düzgün çalışmasını ve sağlam bir şekilde monte edilmesini sağlar. ***Shutter Door Fitting U Profile used in the frame and fixing points of roller shutter doors ensures the door operates smoothly and is securely mounted.</p> <p>***U kanal profil, kapı kasasına vida ile sabitlendikten sonra, panjur paneller vida ile U kanala monte edilir. ***After the U Shaped Profile is fixed to the door frame with screws, the shutter panels are mounted to the U Shaped Profile with screws.</p> <p>***U Kanal Profiller; 1.5mm kalınlıktaki galvanizli sacdan, boyalı veya boyasız olarak üretilmektedir. ***U Shaped Profiles are produced from 1.5mm galvanized sheet metal, either painted or unpainted.</p>			

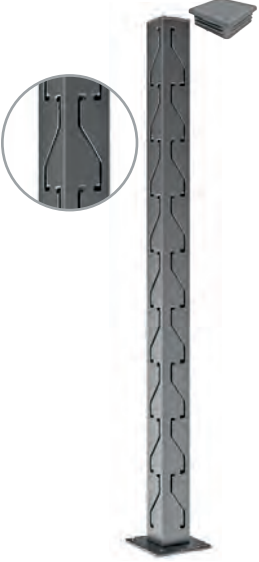
Nemrut Köşe Profil Nemrut Corner Profile			
Görsel Image	Kod Code	Yükseklik Height	Kullanılacak Panel Sayısı Pieces of Panel
	5009-400	400 mm	4
	5009-500	500 mm	5
	5009-600	600 mm	6
	5009-750	750 mm	8
	5009-850	850 mm	9
	5009-940	940 mm	10
	5009-1000	1000 mm	11
	5009-1200	1200 mm	13
	5009-1480	1480 mm	16
	5009-1750	1750 mm	19
	5009-2000	2000 mm	22
<p>***Köşe Profiller, panjur çit projelerinizdeki köşe noktaları için tasarlanmış olup; boyalı veya boyasız olarak üretilmektedir. İstenildiği takdirde diğer modellerimiz için de köşe profil üretimi yapılabilir. ***Corner profiles are designed for corner points in your shutter fence projects and are produced in painted or unpainted according to your needs. Corner profiles can also be produced for our other models if requested.</p> <p>***Köşe profiller; 1.5mm kalınlıktaki 60x60mm GALVANİZLİ profilden üretilmektedir. ***Corner profiles are produced from 60x60mm GALVANIZED profile with 1.5 mm thickness.</p> <p>***Köşe profiller, kendinden kaynaklı 120x120x4mm flanşıyla ve 60x60mm plastik kapağıyla birlikte takım halindedir. ***Each corner post is supplied as a set with its own welded 120x120x4mm flange and 60x60mm plastic lid.</p>			

Kapı Profili Door Profile			
Görsel Image	Kod Code	Yükseklik Height	Kullanılacak Panel Sayısı Pieces of Panel
	5006-1500	1500 mm	15
	5006-2000	2000 mm	21
	5006-2500	2500 mm	26
<p>***Kapı Profilleri, yaya giriş kapıları ve garaj kapıları için tasarlanmıştır. İsteğe bağlı boyalı veya boyasız olarak üretilmektedir. ***Door profiles are designed for pedestrian entrance doors and garage doors. It can be produced in painted or unpainted versions.</p> <p>***Kapı profilleri; 1.5mm kalınlıktaki 60x60mm GALVANİZLİ profilden flanşsız olarak üretilmektedir. ***Door profiles are produced from 60x60mm GALVANIZED profile with 1.5 mm thickness without flange.</p>			



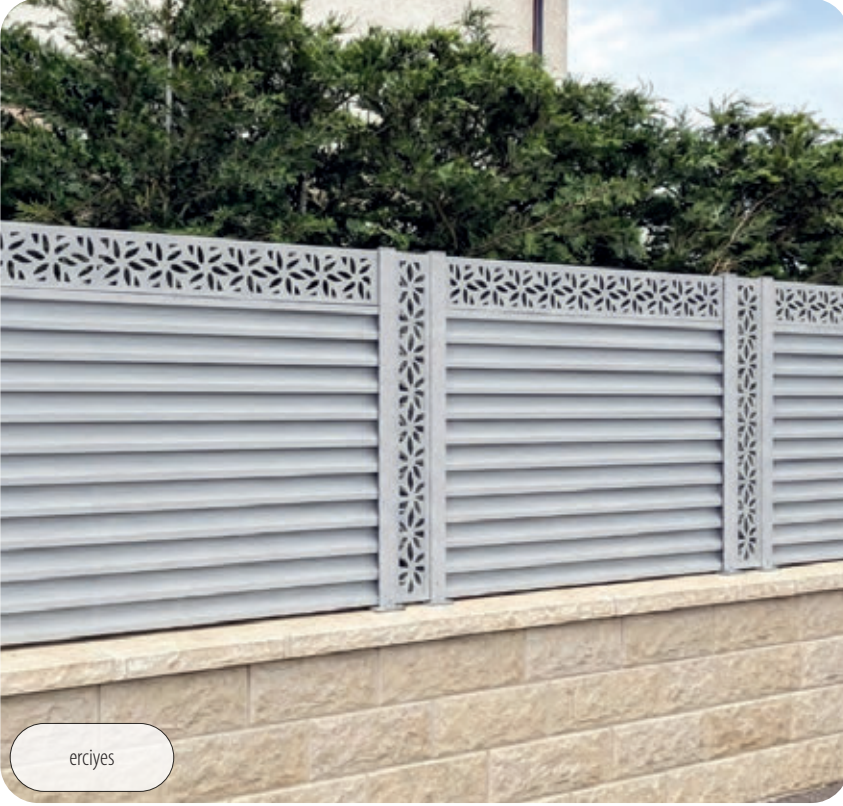

TOROS

lazer kesimli panjur çit/shutter fence with laser-cut

PROFİL
galvanizli profil
flaş kaynaklı
POST
galvanized profile
welded flange

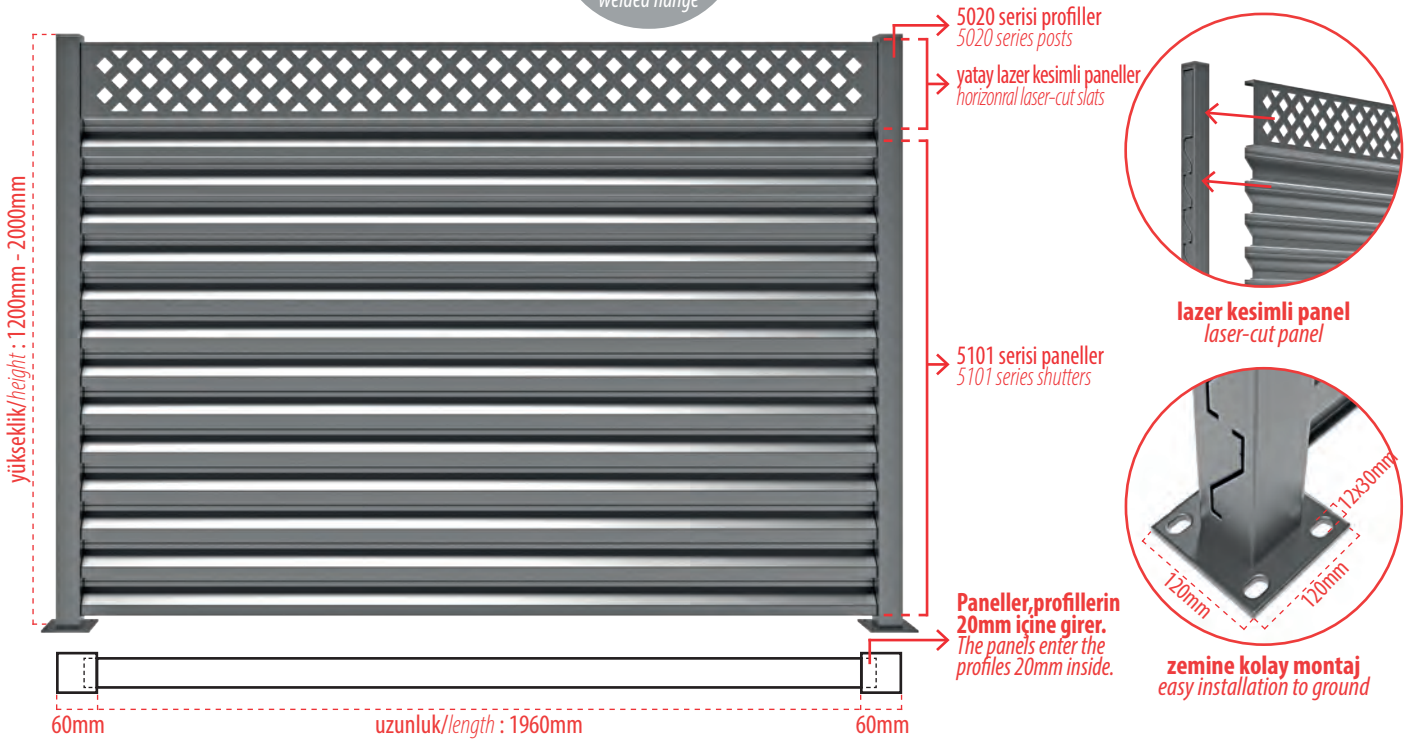

Profil Post			
Görsel Image	Kod Code	Yükseklik Height	Kullanılacak Panel Sayısı Pieces of Panel
	5020-1200	1200 mm	1+11
	5020-1480	1480 mm	1+14
	5020-1750	1750 mm	1+17
	5020-2000	2000 mm	1+20
	***Standart profiller; 1.5mm kalınlıktaki 60x60mm GALVANİZLİ profilden üretilmektedir. ***Standard profiles are produced from 60x60mm GALVANIZED profile with 1.5 mm thickness.		
***Her profil; kendinden kaynaklı 120x120x4mm flaşıyla ve 60x60mm plastik kapağıyla birlikte takım halindedir. ***Each post is supplied as a set with its own welded 120x120x4mm flange and 60x60mm plastic lid.			
***Paneller ve profiller isteğe bağlı olarak, boyalı veya boyasız olarak üretilmektedir. ***Shutters and posts is produced in painted or unpainted versions, upon request.			

Yatay Panel Horizontal Slat			
Görsel Image	Kod Code	Yükseklik Height	Uzunluk Length
	5110-2000	190 mm	2000 mm
	5111-2000	190 mm	2000 mm
	5112-2000	190 mm	2000 mm
***Yatay lazer kesimli paneller; 1.5mm kalınlıktaki galvanizli sacdan üretilmektedir. ***Horizontal laser-cut slats are produced from 1.5mm thickness galvanized sheet metal.			
	5101-2000	90 mm	2000 mm
***5101 seri paneller; 1mm kalınlıktaki galvanizli sacdan üretilmektedir. ***5101 series slats are produced from 1mm thickness galvanized sheet metal.			
***Uygulama Örneği: 120cm yüksekliğindeki Toros model uygulaması için; 5020-1200 kodlu profil + 1 adet yatay lazer kesimli panel + 11 adet 5101-2000 kodlu panjur panel kullanılmaktadır. Bu modelde lazer kesimli panellerin ve panjur panellerinin uzunluğu standart olarak 200cm'dir. ***Application Example: 120cm height Toros model application; Profile code 5020-1200 + 1 horizontal laser-cut panel + 11 shutter panels from the 5101-2000 code are used. In this model, the length of the panels are 200cm as standard.			

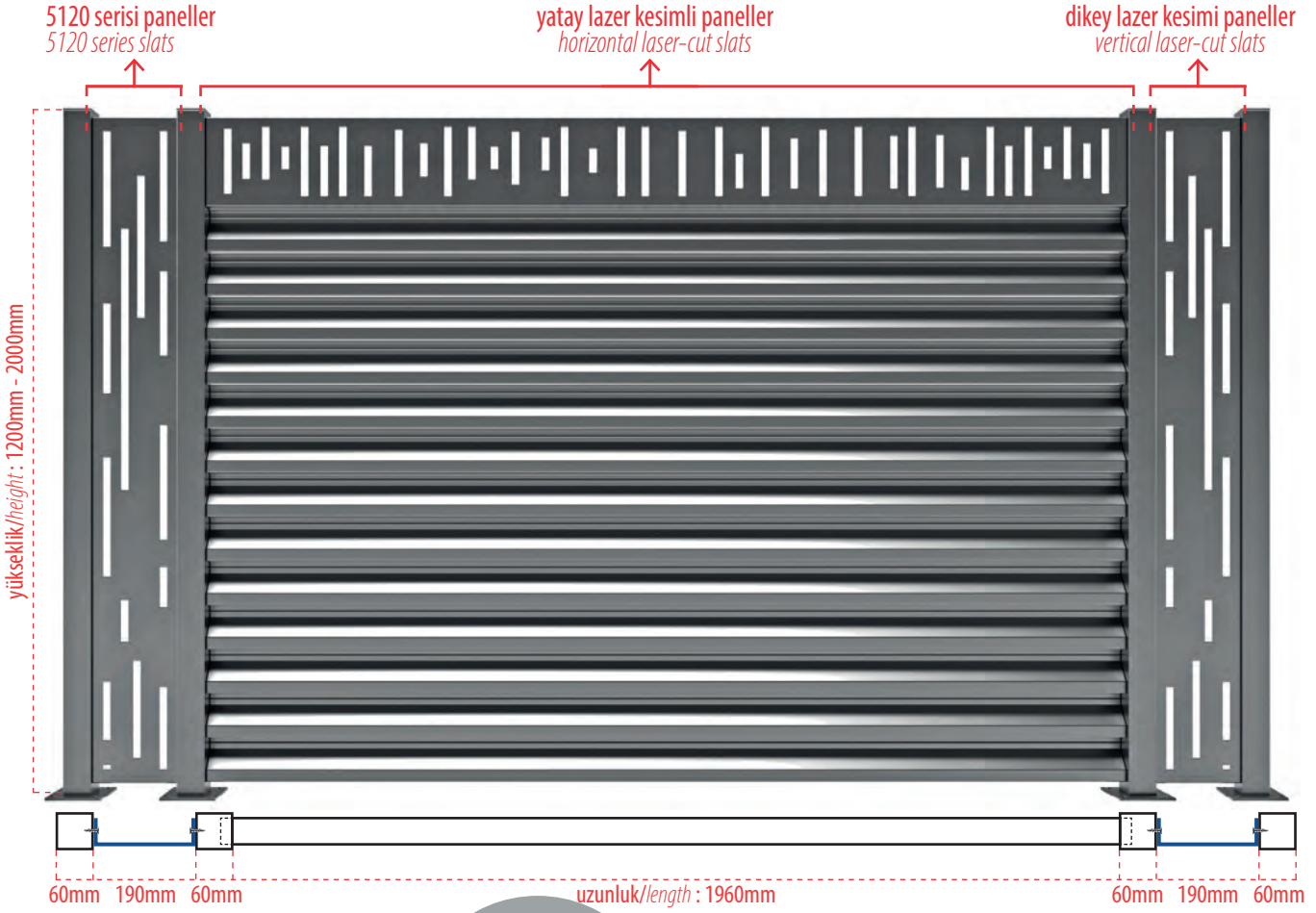

ERCİYES

lazer kesimli panjur çit
shutter fence with laser-cut

Panjur çit sistemine ek olarak panelin üst ve yan kısmına eklenecek yatay ve dikey lazer kesimli paneller ile farklı bir görsel yaratabilirsiniz. Lazer kesimli panelleri; standart desenlerimizden seçebileceğiniz gibi, projenize uygun yazı ve deseni de tercih edebilirsiniz.

4 farklı yükseklik alternatifıyla; mahremiyet ihtiyacını karşıladığı gibi, şık tasarımıyla projelerinize uyum sağlar.

In addition to the shutter fence system, you can create a different visual effect by adding horizontal and vertical laser-cut panels to the top and sides of the panel. You can choose laser-cut panels from our standard designs, or you can opt for text and designs suitable for your project.

With 4 different height alternatives; it meets the need for privacy and adapts to your projects with its stylish design.

PROFİL

galvanizli profil
flanş kaynaklı

POST

galvanized profile
welded flange

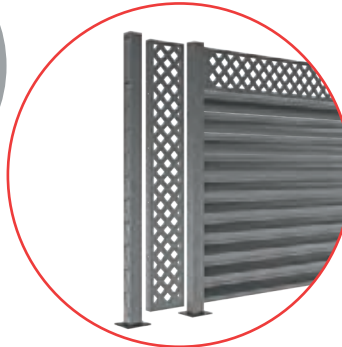

demonte sistem
diy system

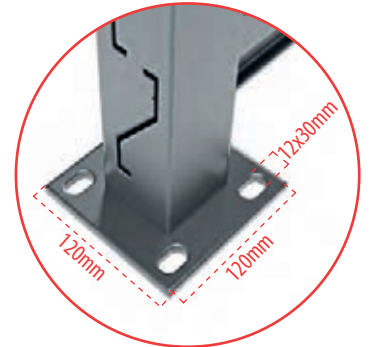

zeminde kolay montaj
easy installation to ground





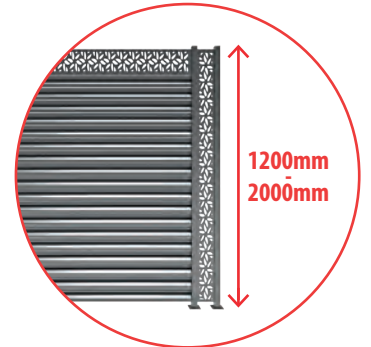



lazer kesimli panel-özel büküm detayı
laser-cut panel and special bending detail

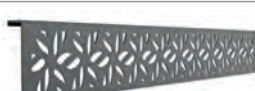

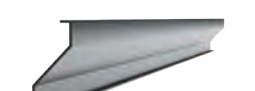
yükseklik çeşitliliği
variety of height

Profil Post			
Görsel Image	Kod Code	Yükseklik Height	Kullanılacak Panel Sayısı Pieces of Panel
	5025-1200	1200 mm	1+11+1
	5025-1480	1480 mm	1+14+1
	5025-1750	1750 mm	1+17+1
	5025-2000	2000 mm	1+20+1
<p>***Standart profiller; 1.5mm kalınlıktaki 60x60mm GALVANİZLİ profilden üretilmektedir. *** Standard profiles are produced from 60x60mm GALVANIZED profile with 1.5 mm thickness.</p> <p>***Her profil; kendinden kaynaklı 120x120x4mm flanşıyla ve 60x60mm plastik kapağıyla birlikte takım halinde dir. ***Each post is supplied as a set with its own welded 120x120x4mm flange and 60x60mm plastic lid.</p> <p>***Paneller ve profiller isteğe bağlı olarak, boyalı veya boyasız olarak üretilmektedir. ***Shutters and posts is produced in painted or unpainted versions, upon request.</p> <p>***Uygulama Örneği: 120cm yüksekliğindeki Erciyes model uygulaması için; 5025-1200 kodlu profil + 1 adet yatay lazer kesimli panel + 11 adet 5101-2000 kodlu panjur panel +1 adet dikey lazer kesimli panel kullanılmaktadır. Bu modelde yatay lazer kesimli panellerin ve panjur panellerinin uzunluğu standart olarak 200cm'dir.</p> <p>***Application Example: 120cm height Erciyes model application; Profile code 5025-1200 + 1 horizontal laser-cut panel + 11 shutter panels from the 5101-2000 code + 1 vertical laser-cut panel are used. In this model, the length of the horizontal panels are 200cm as standard.</p>			

Yatay Panel Horizontal Slat			
Görsel Image	Kod Code	Yükseklik Height	Uzunluk Length
	5110-2000	190 mm	2000 mm
	5111-2000	190 mm	2000 mm
	5112-2000	190 mm	2000 mm
<p>***Yatay lazer kesimli paneller; 1.5mm kalınlıktaki galvanizli sacdan üretilmektedir. ***Horizontal laser-cut slats are produced from 1.5mm thickness galvanized sheet metal.</p>			
	5101-2000	90 mm	2000 mm
<p>***5101 serisi paneller; 1mm kalınlıktaki galvanizli sacdan üretilmektedir. ***5101 series slats are produced from 1mm thickness galvanized sheet metal.</p>			

Dikey Lazer Kesimli Panel Vertical Laser-Cut Slat			
Görsel Image	Kod Code	Genişlik Width	Yükseklik Height
	5120-1170	190 mm	1170 mm
	5120-1450		1450 mm
	5120-1720		1720 mm
	5120-1970		1970 mm
	5121-1170	190 mm	1170 mm
	5121-1450		1450 mm
	5121-1720		1720 mm
	5121-1970		1970 mm
	5122-1170	190 mm	1170 mm
	5122-1450		1450 mm
	5122-1720		1720 mm
	5122-1970		1970 mm
<p>***Dikey lazer kesimli paneller; 1.5mm kalınlıktaki galvanizli sacdan üretilmektedir. ***Vertical laser-cut slats are produced from 1.5mm thickness galvanized sheet metal.</p>			

İLGAZ

yatay lamelli modern çit/horizontal slat modern fence

PROFİL
galvanizli profil
flanş kaynaklı
POST
galvanized profile
welded flange

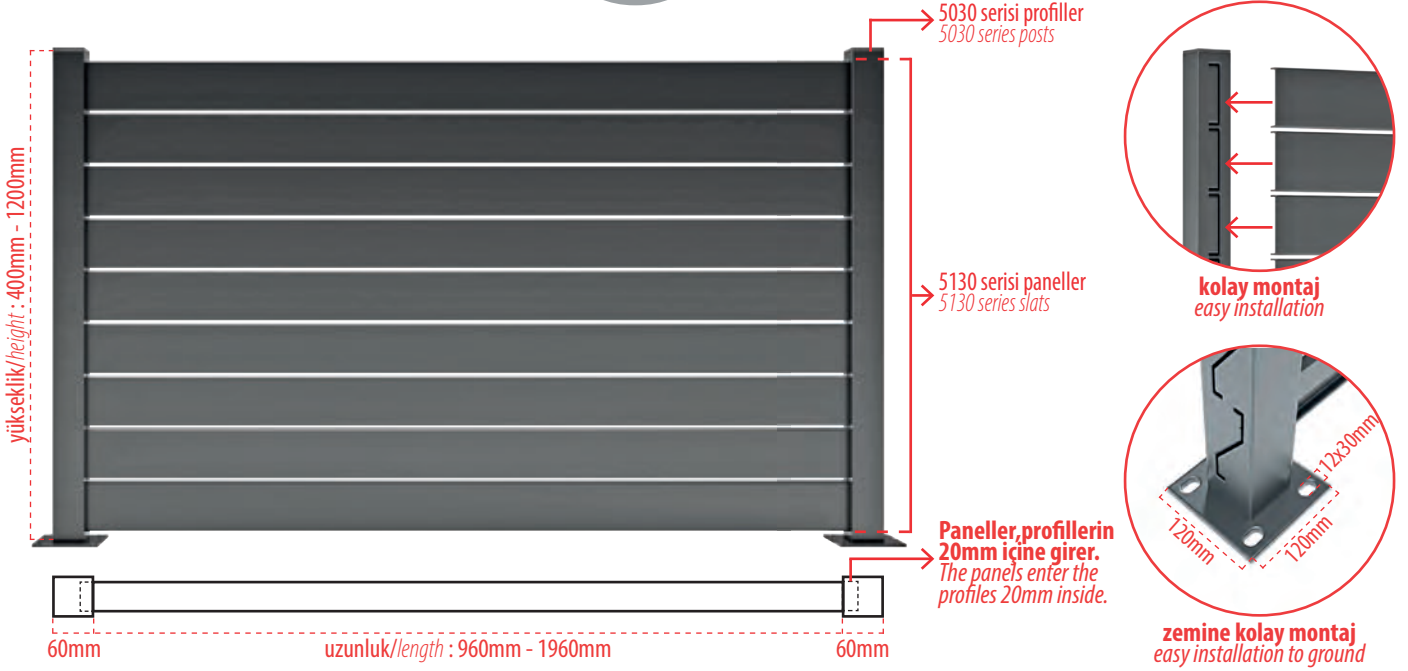

Profil Post			
Görsel Image	Kod Code	Yükseklik Height	Kullanılacak Panel Sayısı Pieces of Panel
	5030-400	400 mm	4
	5030-500	500 mm	5
	5030-600	600 mm	6
	5030-700	700 mm	7
	5030-800	800 mm	8
	5030-900	900 mm	9
	5030-1000	1000 mm	10
	5030-1200	1200 mm	12
	<p>***Standart profiller; 1.5mm kalınlıktaki 60x60mm GALVANİZLİ profilden üretilmektedir. ***Standard profiles are produced from 60x60mm GALVANIZED profile with 1.5 mm thickness.</p> <p>***Her profil; kendinden kaynaklı 120x120x4mm flanşıyla ve 60x60mm plastik kapağıyla birlikte takım halindedir. ***Each post is supplied as a set with its own welded 120x120x4mm flange and 60x60mm plastic lid.</p>		

Yatay Lamel Horizontal Slat			
Görsel Image	Kod Code	Yükseklik Height	Uzunluk Length
	5130-1000	90 mm	1000 mm
	5130-1200	90 mm	1200 mm
	5130-1500	90 mm	1500 mm
	5130-2000	90 mm	2000 mm
	<p>***Paneller; 1mm kalınlıktaki galvanizli sacdan üretilmektedir. ***Slats are produced from 1mm thickness galvanized sheet metal.</p> <p>***Paneller ve profiller isteğe bağlı olarak, boyalı veya boyasız olarak üretilmektedir. ***Shutters and posts is produced in painted or unpainted versions, upon request.</p> <p>***Uygulama Örneği: 120cm yüksekliğindeki İlgaz model uygulaması için; 5030-1200 kodlu profil + 12 adet 5130 serisi yatay lamel kullanılmaktadır. Yatay lamelerde 100cm, 120cm, 150cm ve 200cm uzunluk alternatifleri bulunmaktadır. ***Application Example: 120cm height İlgaz model application; Profile code 5030-1200 + 12 horizontal panel from the 5130 series are used. In this model, horizontal slats are available in lengths of 100cm, 120cm, 150cm, and 200cm.</p>		

AYDOS

yatay lamelli modern çit/horizontal slat modern fence

PROFİL
galvanizli profil
flanş kaynaklı
POST
galvanized profile
welded flange

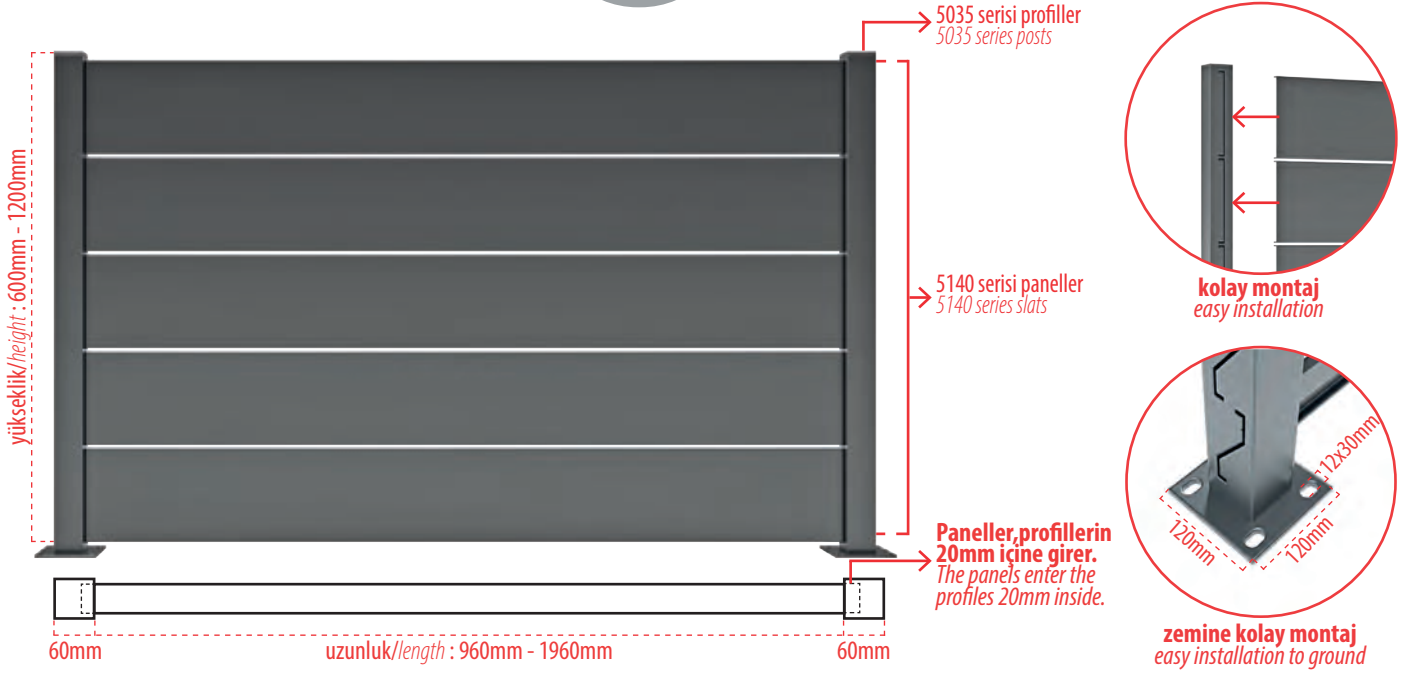

Profil Post			
Görsel Image	Kod Code	Yükseklik Height	Kullanılacak Panel Sayısı Pieces of Panel
	5035-600	600 mm	3
	5035-800	800 mm	4
	5035-1000	1000 mm	5
	5035-1200	1200 mm	6
	***Standart profiller; 1.5mm kalınlıktaki 60x60mm GALVANİZLİ profilden üretilmektedir. *** Standard profiles are produced from 60x60mm GALVANIZED profile with 1.5 mm thickness.		
***Her profil; kendinden kaynaklı 120x120x4mm flanşıyla ve 60x60mm plastik kapağıyla birlikte takım halindedir. ***Each post is supplied as a set with its own welded 120x120x4mm flange and 60x60mm plastic lid.			

Yatay Lamel Horizontal Slat			
Görsel Image	Kod Code	Yükseklik Height	Uzunluk Length
	5140-1000	180 mm	1000 mm
	5140-1200	180 mm	1200 mm
	5140-1500	180 mm	1500 mm
	5140-2000	180 mm	2000 mm
***Paneller; 1mm kalınlıktaki galvanizli sacdan üretilmektedir. ***Slats are produced from 1mm thickness galvanized sheet metal.			
***Paneller ve profiller isteğe bağlı olarak, boyalı veya boyasız olarak üretilmektedir. ***Shutters and posts is produced in painted or unpainted versions, upon request.			
***Uygulama Örneği: 120cm yüksekliğindeki Aydos model uygulaması için; 5035-1200 kodlu profil + 6 adet 5140 serisi yatay lamel kullanılmaktadır. Yatay lamelerde 100cm, 120cm, 150cm ve 200cm uzunluk alternatifleri bulunmaktadır. ***Application Example: 120cm height Aydos model application; Profile code 5035-1200 + 6 horizontal panel from the 5140 series are used. In this model, horizontal slats are available in lengths of 100cm, 120cm, 150cm, and 200cm.			

İDA
lazer kesimli hazır panel/laser-cut panel

PROFİL
galvanizli profil
flaş kaynaklı
POST
galvanized profile
welded flange

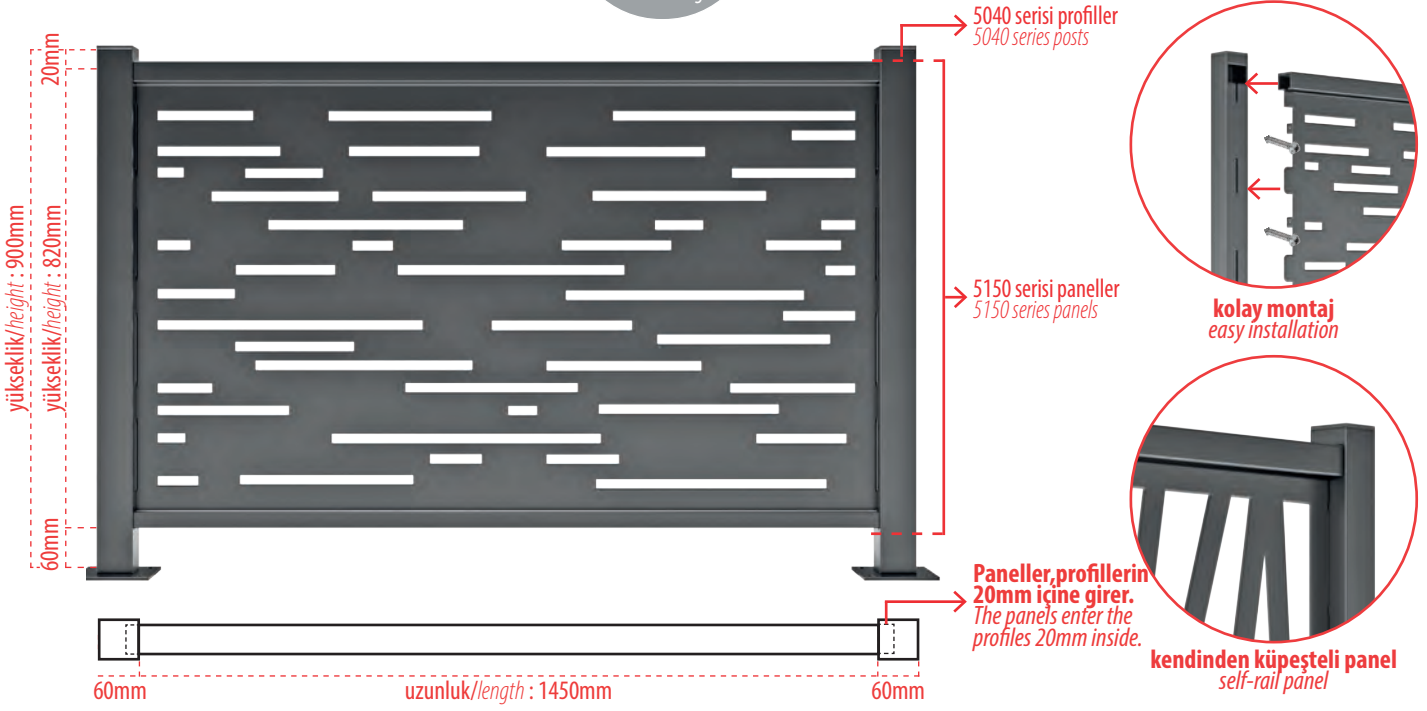

Profil Post		
Görsel Image	Kod Code	Yükseklik Height
	5040-900	900 mm
<p>***Standart profiller; 1.5mm kalınlıktaki 60x60mm galvanizli profilden üretilmektedir. *** Standard profiles are produced from 60x60mm galvanized profile with 1.5 mm thickness.</p> <p>***Her profil; kendinden kaynaklı 120x120x4mm flaşıyla ve 60x60mm plastik kapağıyla birlikte takım halindedir. ***Each post is supplied as a set with its own welded 120x120x4mm flange and 60x60mm plastic lid.</p>		



Lazer Kesimli Panel Laser-Cut Panel			
Kod Code	Desen Kodu Pattern Code	Yükseklik Height	Uzunluk Length
5150-1346		820 mm	1500 mm
5150-1762		820 mm	1500 mm
5150-1160		820 mm	1500 mm
<p>***Paneller; 2mm kalınlıktaki galvanizli sacdan üretilmektedir. ***Slats are produced from 2mm thickness galvanized sheet metal.</p> <p>***Projenize özel istenilen lazer kesim modeli ile boyalı veya boyasız üretim yapılabilir. ***It can be produced painted or unpainted, according to the laser-cut model requested for your project.</p>			

ALP

lazer kesimli hazır panel/laser-cut panel

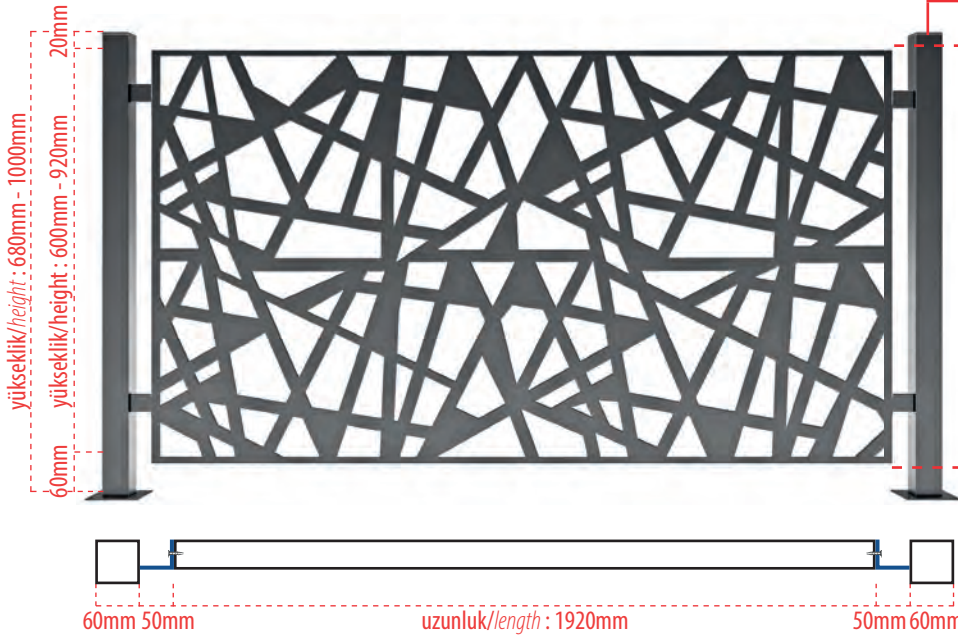
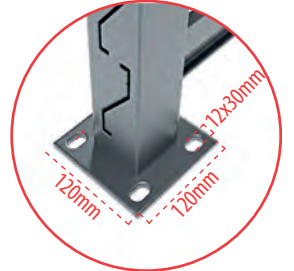

PROFİL
siyah kutu profil
flaş kaynaklı
POST
black box profile
welded flange

5045 serisi profiller
5045 series posts5160 serisi paneller
5160 series panelshazır montaj delikleri
ready installation holeszemine kolay montaj
easy installation to ground

Profil Post				
A Tip A Type	B Tip B Type	C Tip C Type	Kod Code	Yükseklik Height
			5045-680	680 mm
			5045-880	880 mm
			5045-1000	1000 mm

***Standart profiller; 1.5mm kalınlıktaki 60x60mm siyah kutu profilden üretilmektedir. İstenildiği takdirde sıcak daldırma galvaniz kaplama yapılabilir.
*** Standard profiles are produced from 60x60mm black box profile with 1.5 mm thickness. Hot-dip galvanizing is available if required.

***Her profil; kendinden kaynaklı L bağlantı parçası, 120x120x4mm taban flaşı ve 60x60mm plastik kapağıyla birlikte takım halindedir.
***Each profile is supplied as a set with a self-welded L connection piece, 120x120x4mm base flange and 60x60mm plastic lid.

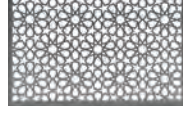
Lazer Kesimli Panel Laser-Cut Panel			
Kod Code	Desen Kodu Pattern Code	Yükseklik Height	Uzunluk Length
5160-600	 1762	600 mm	1920 mm
5160-800	 1252	800 mm	1920 mm
5160-920	 1160	920 mm	1920 mm

***Standart paneller; 2mm kalınlıktaki siyah sacdan üretilmekte olup, 4 tarafı bükümlüdür. İstenildiği takdirde galvanizli sacdan da üretim yapılabilir.
***Standard panels are produced from 2mm black sheet metal and are bent on 4 sides.

***Projenize özel istenilen lazer kesim modeli ile boyalı veya boyasız üretim yapılabilir.
***It can be produced painted or unpainted, according to the laser-cut model requested for your project.

***Özel kulakçıklı yapısı ve montaj delikleri sayesinde kolay kurulum sağlar.
*** With L design parts and mounting holes, it ensures easy installation.

EVEREST
genişletilmiş metal panel/mesh panel

PROFİL
siyah kutu profil
flaş kaynaklı
POST
black box profile
welded flange

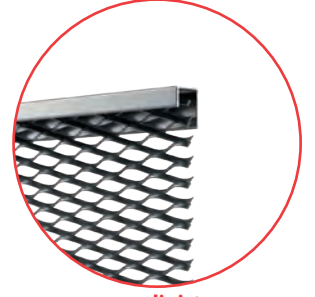
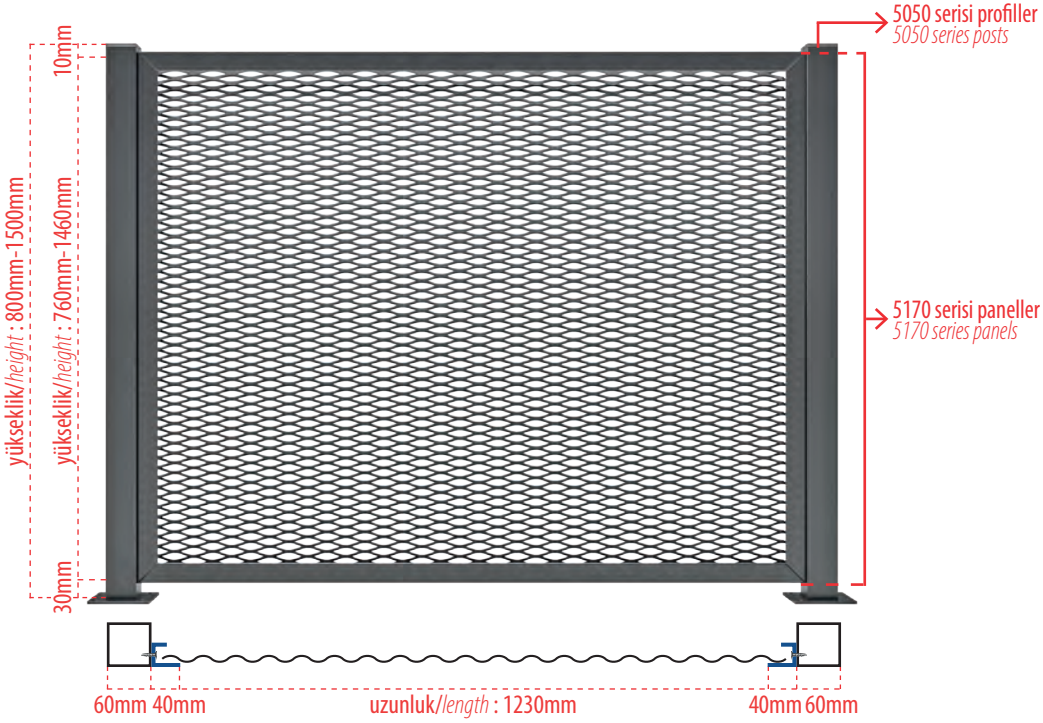

çerçevesi sistem
frame system

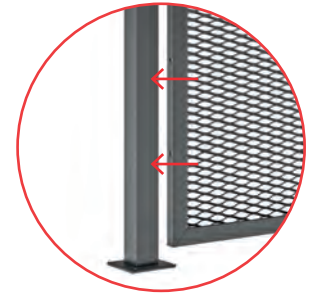

hazır montaj delikleri
ready installation holes

Profil Post		
Görsel Image	Kod Code	Yükseklik Height
	5050-800	800 mm
	5050-1000	1000 mm
	5050-1200	1200 mm
	5050-1500	1500 mm
<p>***Standart profiller; 1.5mm kalınlıktaki 60x60mm siyah kutu profilden üretilmektedir. *** Standard profiles are produced from 60x60mm black box profile with 1.5 mm thickness.</p> <p>***Her profil; kendinden kaynaklı 120x120x4mm flaşıyla ve 60x60mm plastik kapağıyla birlikte takım halindedir. ***Each post is supplied as a set with its own welded 120x120x4mm flange and 60x60mm plastic lid.</p>		

Genişletilmiş Metal Panel Expanded Metal Panel			
Görsel Image	Kod Code	Yükseklik Height	Uzunluk Length
	5170-760	760 mm	1310 mm
	5170-960	960 mm	1310 mm
	5170-1160	1160 mm	1310 mm
	5170-1460	1460 mm	1310 mm
<p>***Paneller; 76/31mm göz aralığı ölçüsü olan 2mm kalınlıktaki genişletilmiş metalden üretilmekte olup, dış çerçevesi 2mm sacdan üretilmiştir. ***Panels are produced from 2mm thick expanded metal with a mesh size of 76/31mm and the frame is produced from 2mm sheet metal.</p> <p>*** İstenilen farklı göz aralıklarında ve farklı kalınlıklarda boyalı veya boyasız üretim yapılabilir. ***It can be produced painted or unpainted, in different desired mesh sizes and thicknesses.</p>			

FUJİ

plastik ferforje panel/plastic ferforge panel

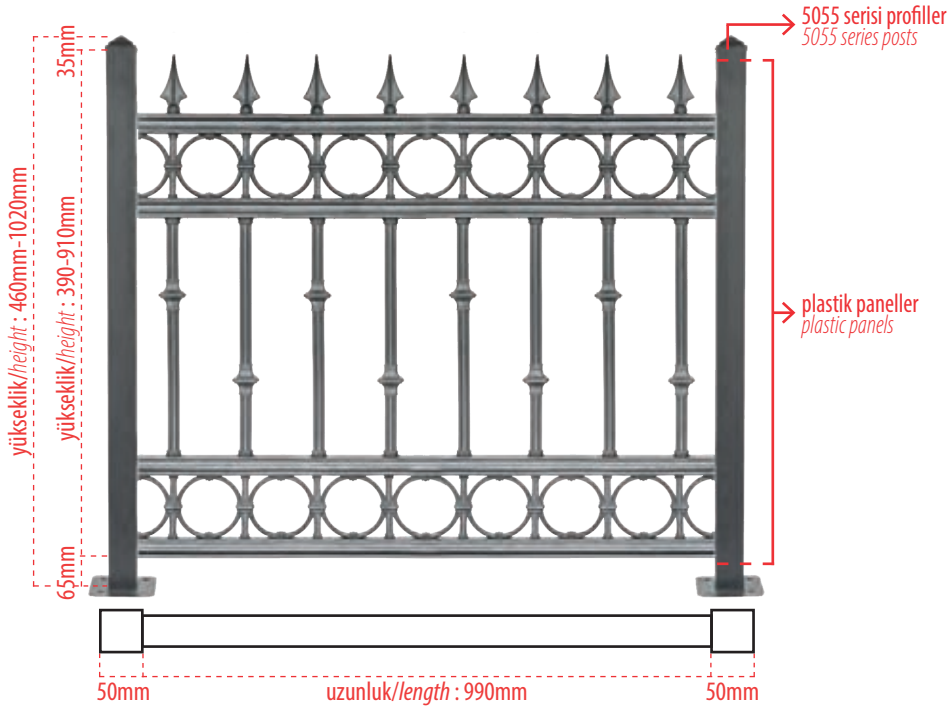
**PLASTİK
PLASTIC****ekonomik fiyat**
low cost**galvanizli statik boyalı profil**
galvanized and painted profile

Profil Post			
Görsel Image	Kod Code	Yükseklik Height	Ağırlık Weight
	5055-460	460 mm	1,20kg
	5055-860	860 mm	2,00kg
	5055-1020	1020 mm	2,25kg
<p>***Standart profiller (50x50x1.5mm); galvanizli, statik boyalı ve kendinden kaynaklı flanşıyla ve plastik kapağıyla birlikte takım halindedir.</p> <p>*** Standard posts (50x50x1.5mm) are galvanized, painted and supplied as a set with its own welded flange and plastic lid.</p> <p>*** Standart olarak siyah renkte üretilmektedir. 350 metre ve üzeri siparişlerde özel renk üretimi yapılabilir.</p> <p>***It is produced in black color as standard. Special color production is available for orders of 350 meters and above.</p>			

Plastic Panel Plastic Panel				
Görsel Image	Kod Code	Yükseklik Height	Uzunluk Length	Ağırlık Weight
	5190-390	390 mm	990 mm	3,50kg
	5191-750	750 mm	990 mm	4,30kg
	5191-910	910 mm	990 mm	5,60kg
<p>***Paneller; plastikten üretilmiş olup, 4 parça halinde gelmektedir.</p> <p>***Panels are produced from plastic and comes in 4 pieces.</p> <p>***Paneller montaj için gerekli olan tüm elemanları ile birlikte takım halindedir. (galvanizli ve plastik bağlantı gijonları, plastik bağlantı pulları, plastik somunları ve yan kapakları)</p> <p>***Panels are in a set with all the elements required for assembly. (galvanized and plastic connecting rods, plastic connecting washers, plastic tiejon nuts and side covers)</p>				

PLASTİK SUNDURMA

plastic canopy

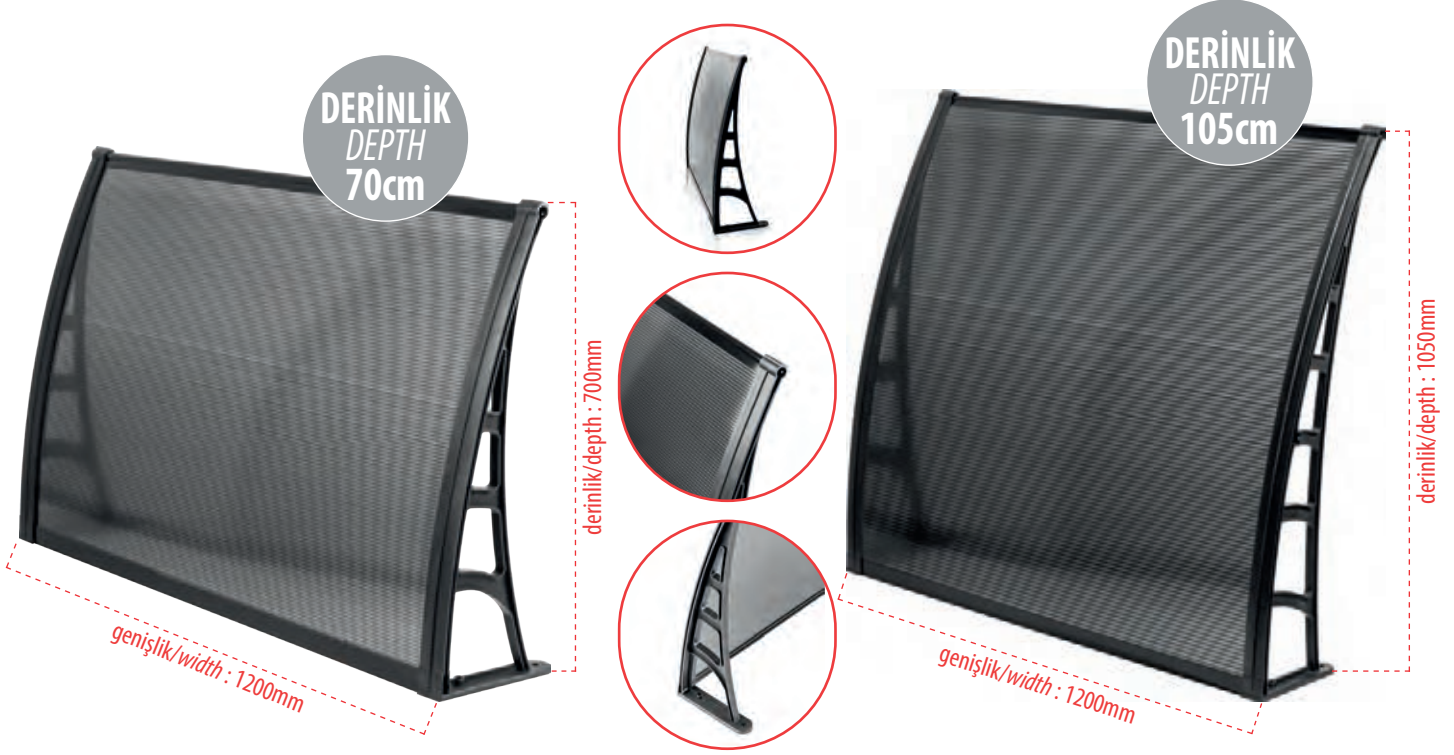

Sundurma Canopy			
Görsel Image	Kod Code	Derinlik Depth	Genişlik Width
	5200-700x1200	700 mm	1200 mm
	5200-700x2400	700 mm	2400 mm
<p>***Ayaklar polipropilen plastik enjeksiyon malzemeden üretilmekte olup, siyah renktedir. ***Feet are made of polypropylene plastic injection material and are black in color.</p> <p>***Çatı levhası 4mm polikarbon levha olmakla birlikte, isteğe göre şeffaf ve siyah renk seçenekleri mevcuttur. ***The roof sheet is 4mm polycarbonate sheet, transparent and black options are available upon request.</p> <p>***120cm ve katlarında üretim yapılabilir. ***Production can be done in increments of 120 cm.</p> <p>*** Tüm kurulum malzemeleri ile paket halinde teslim edilmektedir. ***It is delivered as a package with all installation materials included.</p>			

Sundurma Canopy			
Görsel Image	Kod Code	Derinlik Depth	Genişlik Width
	5201-1050x1200	1050 mm	1200 mm
	5201-1050x2400	1050 mm	2400 mm
<p>***Ayaklar polipropilen plastik enjeksiyon malzemeden üretilmekte olup, siyah renktedir. ***Feet are made of polypropylene plastic injection material and are black in color.</p> <p>***Çatı levhası 4mm polikarbon levha olmakla birlikte, isteğe göre şeffaf ve siyah renk seçenekleri mevcuttur. ***The roof sheet is 4mm polycarbonate sheet, transparent and black options are available upon request.</p> <p>***120cm ve katlarında üretim yapılabilir. ***Production can be done in increments of 120 cm.</p> <p>*** Tüm kurulum malzemeleri ile paket halinde teslim edilmektedir. ***It is delivered as a package with all installation materials included.</p>			



Cephe ve Güneş Kırıcı Genişletilmiş Metal Alternatifleri - Expanded Metal Alternatives for Facade and Sun Louvres

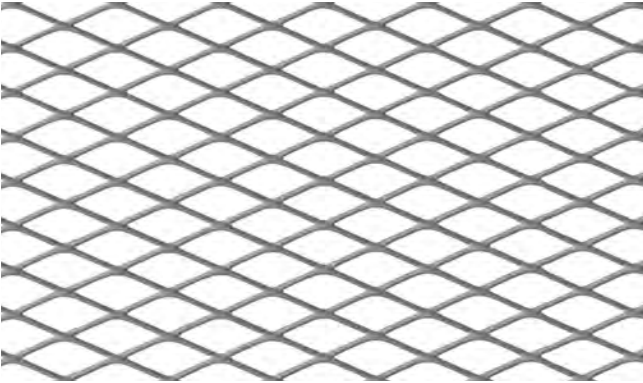
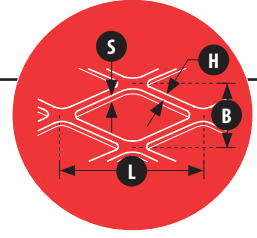

Kod Code	Göz Aralığı Braid Width x Braid Length	Sac Kalınlığı Sheet Thickness	Hatve Strip Width	Malzeme Material	Ağırlık Weight
	L / B	S	H		(m2/kg)
0703	30/13	1.5 mm	3 mm	DKP	5,45
		2 mm	3 mm	DKP	7,30
		2 mm	3 mm	Alüminyum	2,80

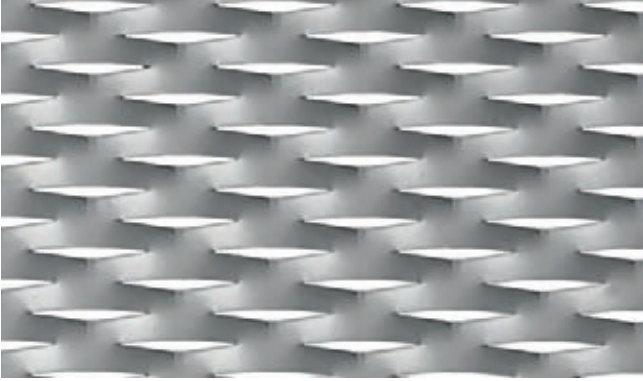

Kod Code	Göz Aralığı Braid Width x Braid Length	Sac Kalınlığı Sheet Thickness	Hatve Strip Width	Malzeme Material	Ağırlık Weight
	L / B	S	H		(m2/kg)
0705	50/18	1.5 mm	8 mm	DKP	10,50
		2 mm	8 mm	DKP	14,00
		2 mm	8 mm	Alüminyum	5,00

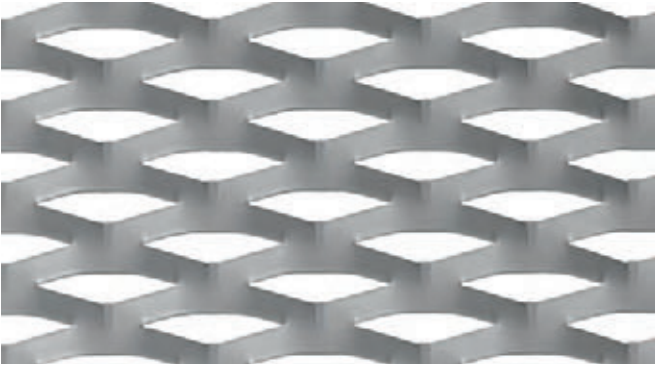

Kod Code	Göz Aralığı Braid Width x Braid Length	Sac Kalınlığı Sheet Thickness	Hatve Strip Width	Malzeme Material	Ağırlık Weight
	L / B	S	H		(m2/kg)
0706	62/24	1.5 mm	7 mm	DKP	6,90
		2 mm	7 mm	DKP	9,20
		2 mm	7 mm	Alüminyum	3,30

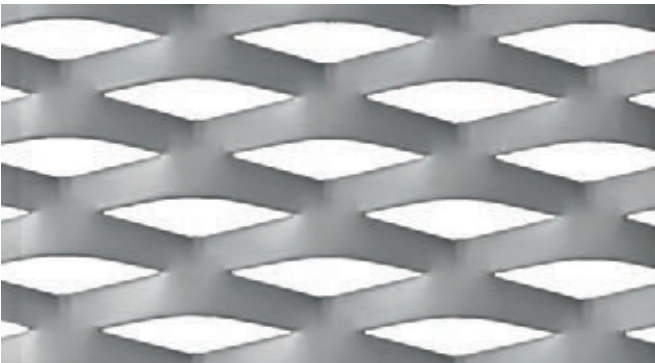

Kod Code	Göz Aralığı Braid Width x Braid Length	Sac Kalınlığı Sheet Thickness	Hatve Strip Width	Malzeme Material	Ağırlık Weight
	L / B	S	H		(m2/kg)
0708	76/31	1.5 mm	9 mm	DKP	6,85
		2 mm	9 mm	DKP	9,15
		2 mm	9 mm	Alüminyum	3,25

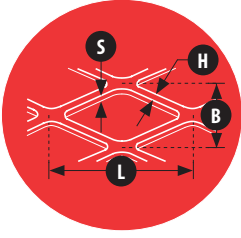

Kod Code	Göz Aralığı Braid Width x Braid Length	Sac Kalınlığı Sheet Thickness	Hatve Strip Width	Malzeme Material	Ağırlık Weight
	L / B	S	H		(m2/kg)
0709	94/38	1.5 mm	11 mm	DKP	6,85
		2 mm	11 mm	DKP	9,10
		2 mm	11 mm	Alüminyum	3,25

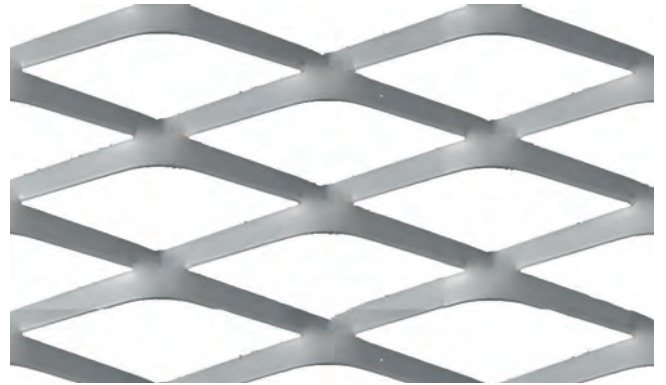

Kod Code	Göz Aralığı Braid Width x Braid Length	Sac Kalınlığı Sheet Thickness	Hatve Strip Width	Malzeme Material	Ağırlık Weight
	L / B	S	H		(m2/kg)
0710-A	100/50	1.5 mm	16 mm	DKP	7,60
		1.5 mm	20 mm	DKP	9,50
		2 mm	16 mm	DKP	10,10
		2 mm	20 mm	DKP	12,60
		2 mm	16 mm	Alüminyum	3,60
		2 mm	20 mm	Alüminyum	4,50

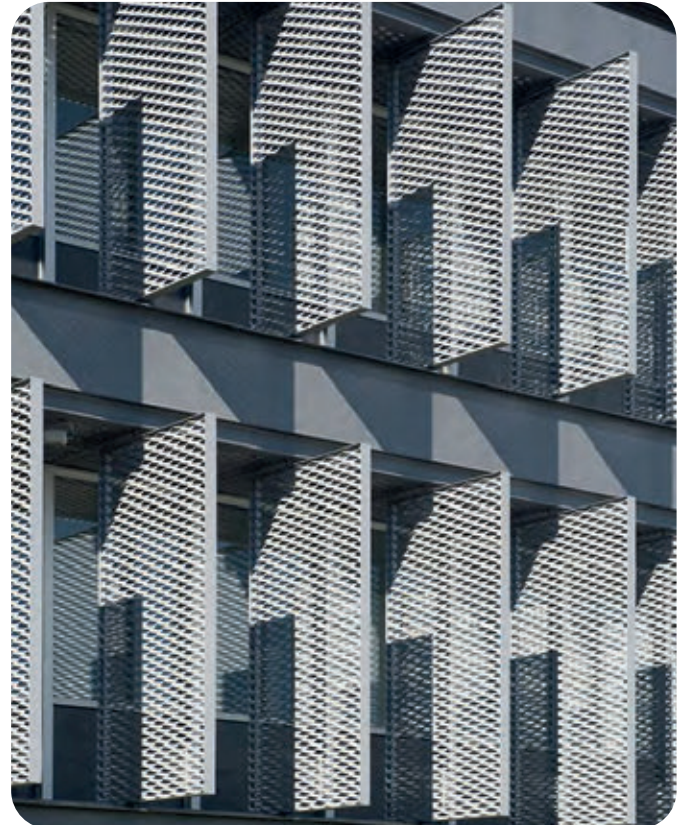
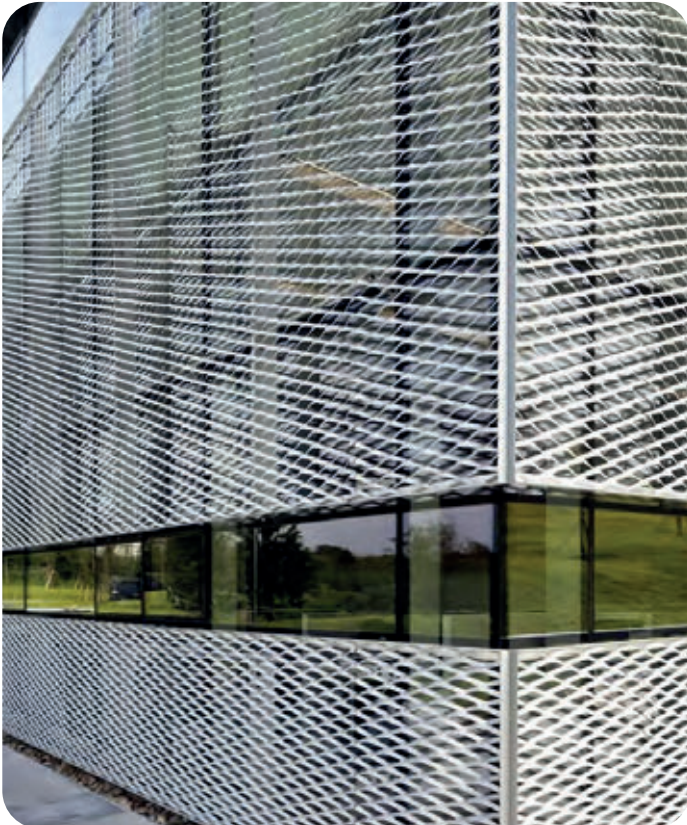
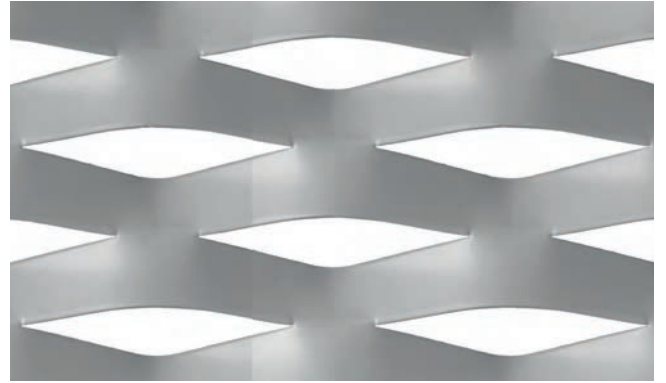

Asma Tavan Genişletilmiş Metal Alternatifleri - *Expanded Metal Alternatives for Ceiling*

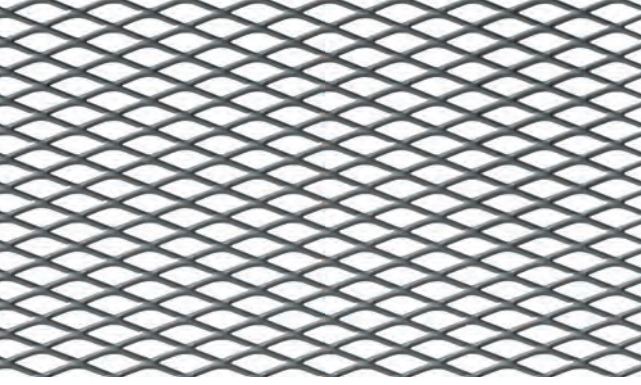
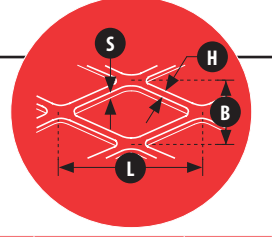

Kod Code	Göz Aralığı Braid Width x Braid Length	Sac Kalınlığı Sheet Thickness	Hatve Strip Width	Malzeme Material	Ağırlık Weight
	L / B	S	H		(m2/kg)
0702-A	20/8	1 mm	1.5 mm	DKP	2,95
		1 mm	2 mm	DKP	3,93

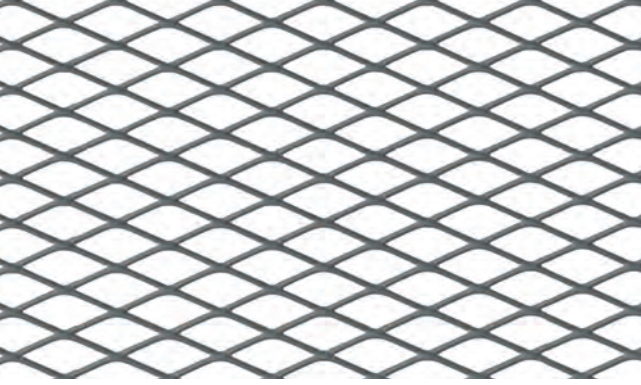

Kod Code	Göz Aralığı Braid Width x Braid Length	Sac Kalınlığı Sheet Thickness	Hatve Strip Width	Malzeme Material	Ağırlık Weight
	L / B	S	H		(m2/kg)
0703	30/13	1 mm	2 mm	DKP	2,40

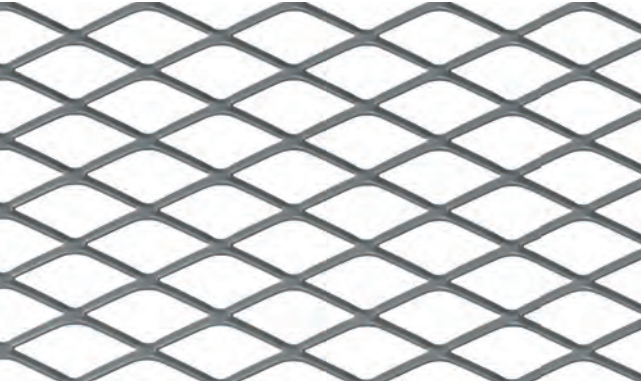

Kod Code	Göz Aralığı Braid Width x Braid Length	Sac Kalınlığı Sheet Thickness	Hatve Strip Width	Malzeme Material	Ağırlık Weight
	L / B	S	H		(m2/kg)
0704-A	40/20	1 mm	3 mm	DKP	2,38

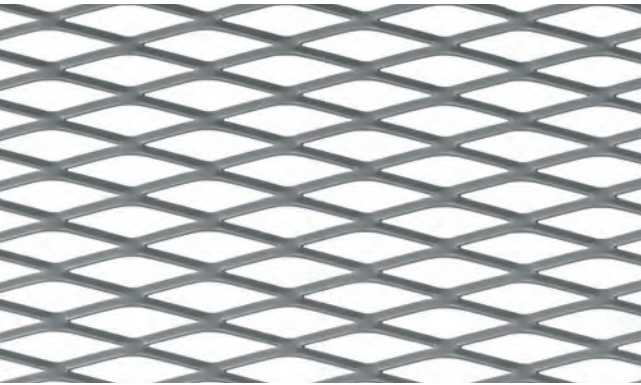

Kod Code	Göz Aralığı Braid Width x Braid Length	Sac Kalınlığı Sheet Thickness	Hatve Strip Width	Malzeme Material	Ağırlık Weight
	L / B	S	H		(m2/kg)
0704	42/14	1 mm	2.5 mm	DKP	2,83

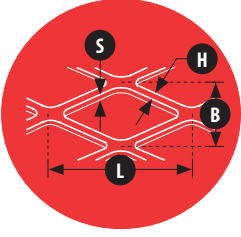

Kod Code	Göz Aralığı Braid Width x Braid Length	Sac Kalınlığı Sheet Thickness	Hatve Strip Width	Malzeme Material	Ağırlık Weight
	L / B	S	H		(m2/kg)
0705	50/18	1 mm	2.5 mm	DKP	2,20

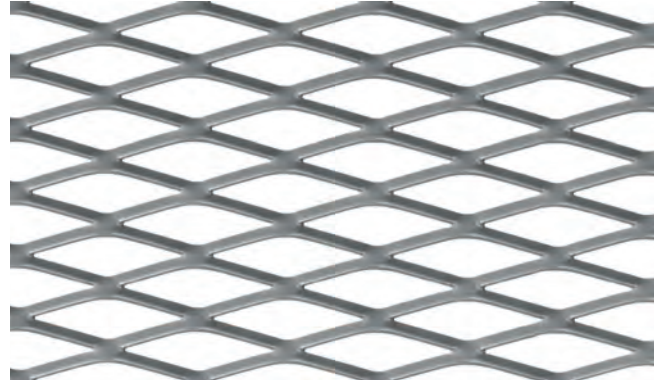

Kod Code	Göz Aralığı Braid Width x Braid Length	Sac Kalınlığı Sheet Thickness	Hatve Strip Width	Malzeme Material	Ağırlık Weight
	L / B	S	H		(m2/kg)
0706	62/24	1 mm	4 mm	DKP	2,65

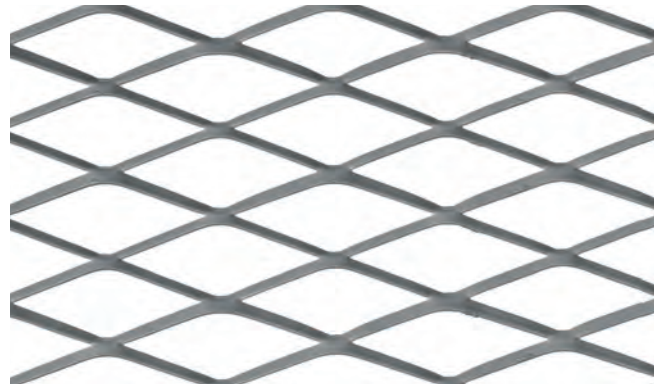

Kod Code	Göz Aralığı Braid Width x Braid Length	Sac Kalınlığı Sheet Thickness	Hatve Strip Width	Malzeme Material	Ağırlık Weight
	L / B	S	H		(m2/kg)
0708	76/31	1 mm	5 mm	DKP	2,55

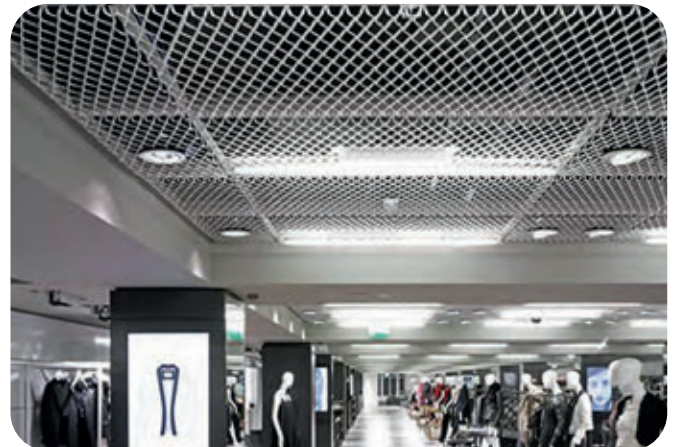
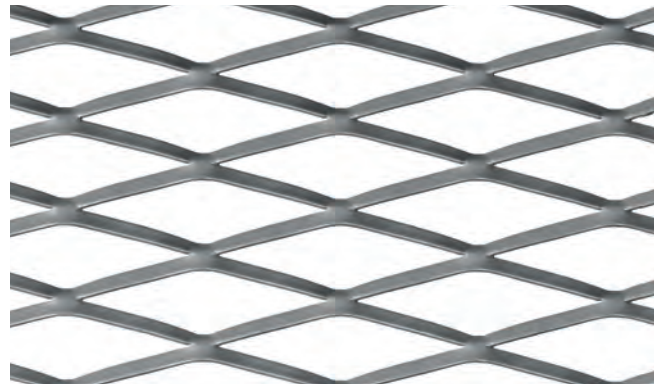

GENİŞLETİLMİŞ METAL YAPILABİRLİK TABLOSU / EXPANDED METAL DIMENSION TABLE

Kod Code	Göz Aralığı (mm) Braid Width x Braid Length	Sac Kalınlığı S (mm) Sheet Thickness	Hatve H (mm) Strip Width	Ebatlar Dimension			Ebatlar Dimension			Ebatlar Dimension		
				En (mm) Width	Boy (mm) Length	Ağırlık (kg) Weight	En (mm) Width	Boy (mm) Length	Ağırlık (kg) Weight	En (mm) Width	Boy (mm) Length	Ağırlık (kg) Weight
0700	10/5	0,5	1	1000	2000	3,20	1250	2500	5,00	-	-	-
		1	1	1000	2000	6,40	1250	2500	10,00	-	-	-
0701	13/7	1	1	1000	2000	4,60	1250	2500	7,19	-	-	-
		1,5	2	1000	2000	13,70	1250	2500	21,40	-	-	-
0702-A	20/8	1	1,5	1000	2000	5,90	1250	2500	9,22	-	-	-
		1	2	1000	2000	7,85	1250	2500	12,27	-	-	-
		1,5	2,5	1000	2000	14,72	1250	2500	23,00	1500	3000	33,12
		2	3	1000	2000	23,55	1250	2500	36,80	1500	3000	52,99
0702	25/8	1	1	1000	2000	8,00	1250	2500	12,50	-	-	-
		1,5	2,5	1000	2000	15,00	1250	2500	23,44	1500	3000	33,75
		2	3	1000	2000	24,60	1250	2500	38,44	1500	3000	55,35
0703	30/13	1	2	1000	2000	4,80	1250	2500	7,50	-	-	-
		1,5	2,5	1000	2000	9,20	1250	2500	14,38	1500	3000	20,70
		1,5	3	1000	2000	10,90	1250	2500	17,05	1500	3000	24,55
		2	3	1000	2000	14,60	1250	2500	22,85	1500	3000	32,85
		3	4	1000	2000	29,00	1250	2500	45,31	1500	3000	65,25
0704-A	40/20	1	2	1000	2000	3,14	1250	2500	4,91	-	-	-
		1	3	1000	2000	4,75	1250	2500	7,45	-	-	-
		1,5	2,5	1000	2000	5,89	1250	2500	9,20	1500	3000	13,25
		2	3	1000	2000	9,42	1250	2500	14,72	1500	3000	21,20
		3	4	1000	2000	18,84	1250	2500	29,44	1500	3000	42,39
		4	5	1000	2000	31,40	1250	2500	49,06	1500	3000	70,65
0704	42/14	1	2	1000	2000	4,60	1250	2500	7,19	-	-	-
		1	2,5	1000	2000	5,65	1250	2500	8,85	-	-	-
		1,5	2,5	1000	2000	8,60	1250	2500	13,44	1500	3000	19,35
		2	3	1000	2000	13,60	1250	2500	21,25	1500	3000	30,60
		3	4	1000	2000	27,40	1250	2500	42,81	1500	3000	61,65
		4	5	1000	2000	45,60	1250	2500	71,25	1500	3000	102,60
0705	50/18	1	2,5	1000	2000	4,40	1250	2500	6,90	-	-	-
		1,5	2,5	1000	2000	6,60	1250	2500	10,31	1500	3000	14,85
		1,5	8	1000	2000	21,00	1250	2500	32,85	1500	3000	47,25
		2	3	1000	2000	10,60	1250	2500	16,56	1500	3000	23,85
		2	8	1000	2000	28,00	1250	2500	43,75	1500	3000	63,00
		3	4	1000	2000	21,20	1250	2500	33,13	1500	3000	47,70
		4	5	1000	2000	35,40	1250	2500	55,31	1500	3000	79,65
		5	6	1000	2000	53,20	1250	2500	83,13	1500	3000	119,70

****0,50 mm ve 1 mm kalınlıktaki genişletilmiş metaller ütülü olarak üretilmektedir.**
 **expanded metals with thicknesses of 0.50 mm and 1 mm are produced as standard with a flattened.

GENİŞLETİLMİŞ METAL YAPILABİRLİK TABLOSU / EXPANDED METAL DIMENSION TABLE												
Kod Code	Göz Aralığı (mm) Braid Width x Braid Length	Sac Kalınlığı S (mm) Sheet Thickness	Hatve H (mm) Strip Width	Ebatlar Dimension			Ebatlar Dimension			Ebatlar Dimension		
				En (mm) Width	Boy (mm) Length	Ağırlık (kg) Weight	En (mm) Width	Boy (mm) Length	Ağırlık (kg) Weight	En (mm) Width	Boy (mm) Length	Ağırlık (kg) Weight
0706	62/24	1	4	1000	2000	5,30	1250	2500	8,30	-	-	-
		1,5	7	1000	2000	13,80	1250	2500	21,60	1500	3000	31,05
		2	3	1000	2000	18,35	1250	2500	28,70	1500	3000	41,30
		2	7	1000	2000	8,10	1250	2500	12,66	1500	3000	18,23
		3	4	1000	2000	16,00	1250	2500	25,00	1500	3000	36,00
		3	7	1000	2000	26,00	1250	2500	40,63	1500	3000	58,50
		4	5	1000	2000	28,60	1250	2500	44,69	1500	3000	64,35
		4	7	1000	2000	37,00	1250	2500	57,81	1500	3000	83,25
		5	6	1000	2000	40,00	1250	2500	62,50	1500	3000	90,00
		5	7	1000	2000	46,00	1250	2500	71,88	1500	3000	103,50
0708	76/31	1	5	1000	2000	5,10	1250	2500	8,00	-	-	-
		1,5	9	1000	2000	13,70	1250	2500	21,40	1500	3000	30,83
		2	2,5	1000	2000	5,20	1250	2500	8,13	1500	3000	11,70
		2	9	1000	2000	18,30	1250	2500	28,60	1500	3000	41,20
		3	4	1000	2000	12,40	1250	2500	19,38	1500	3000	27,90
		4	5	1000	2000	20,40	1250	2500	31,88	1500	3000	45,90
		5	6	1000	2000	31,20	1250	2500	48,75	1500	3000	70,20
0709	94/38	1,5	11	1000	2000	13,70	1250	2500	21,40	1500	3000	30,85
		2	3	1000	2000	5,00	1250	2500	7,81	1500	3000	11,25
		2	11	1000	2000	18,20	1250	2500	28,45	1500	3000	40,95
		3	4	1000	2000	10,00	1250	2500	15,63	1500	3000	22,50
		4	5	1000	2000	16,80	1250	2500	26,25	1500	3000	37,80
		5	6	1000	2000	25,20	1250	2500	39,38	1500	3000	56,70
0710-A	100/50	1,5	16	1000	2000	15,20	1250	2500	23,75	1500	3000	34,20
		1,5	20	1000	2000	19,00	1250	2500	29,70	1500	3000	42,75
		2	16	1000	2000	20,20	1250	2500	31,60	1500	3000	45,45
		2	20	1000	2000	25,20	1250	2500	39,40	1500	3000	56,70
		3	4	1000	2000	7,54	1250	2500	11,78	1500	3000	16,96
		4	5	1000	2000	12,56	1250	2500	19,63	1500	3000	28,26
		5	6	1000	2000	18,84	1250	2500	29,44	1500	3000	42,39
0710	110/45	3	4	1000	2000	8,60	1250	2500	13,44	1500	3000	19,35
		4	5	1000	2000	14,00	1250	2500	21,88	1500	3000	31,50
		5	6	1000	2000	21,20	1250	2500	33,13	1500	3000	47,70

****0,50 mm ve 1 mm kalınlıktaki genişletilmiş metaller ütülü olarak üretilmektedir.**
****expanded metals with thicknesses of 0.50 mm and 1 mm are produced as standard with a flattened.**

Yuvarlak Delikli Saclar - Round Hole Perforated Sheets

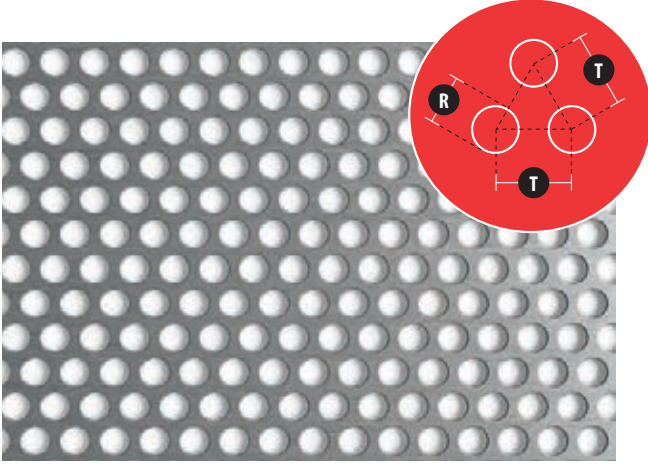

Kod Code	Delik Çapı Hole Size	Merkezler Arası Mesafe Distance Between Centers	Sac Kalınlığı Sheet Thickness	Tabaka Ölçüsü Plate Dimension	Boşluk Oranı Open Area
	R	T	S		
0771	Ø3 mm	6 mm	1 mm	1000x2000 mm	%20
0772	Ø4 mm	8 mm	1 mm	1000x2000 mm	%19
0772-A	Ø5 mm	10 mm	1 mm	1000x2000 mm	%20
0773	Ø6 mm	10 mm	1 mm	1000x2000mm	%27
0773-A	Ø7 mm	12 mm	1 mm	1000x2000 mm	%28
0774	Ø8 mm	12 mm	1 mm	1000x2000 mm	%36
0775	Ø10 mm	16 mm	1 mm	1000x2000 mm	%30
0776	Ø12 mm	19 mm	1 mm	1000x2000 mm	%33
0777	Ø14 mm	22 mm	1 mm	1000x2000 mm	%32

Kare Delikli Saclar - Square Hole Perforated Sheets

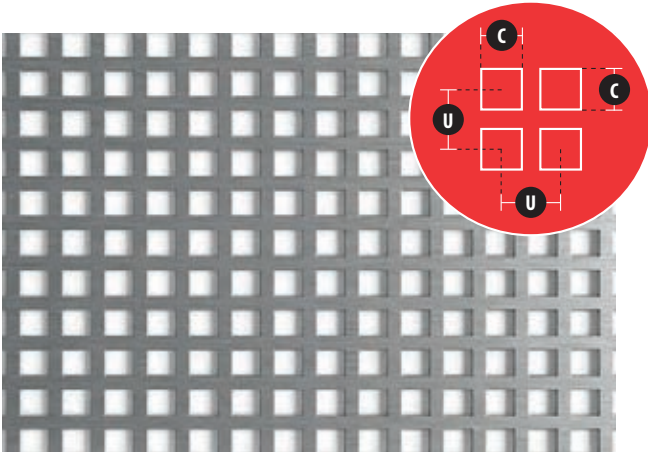

Kod Code	Delik Ölçüsü Hole Size	Merkezler Arası Mesafe Distance Between Centers	Sac Kalınlığı Sheet Thickness	Tabaka Ölçüsü Plate Dimension	Boşluk Oranı Open Area
	C	U	S		
0780	5x5 mm	8 mm	1 mm	1000x2000 mm	%34
0781	8x8 mm	14 mm	1 mm	1000x2000 mm	%31
0782	10x10 mm	19 mm	1 mm	1000x2000 mm	%24
0783	15x15 mm	26 mm	1 mm	1000x2000 mm	%31
0784	20x20 mm	29 mm	1 mm	1000x2000 mm	%44

Oval Delikli Saclar - Oval Hole Perforated Sheets

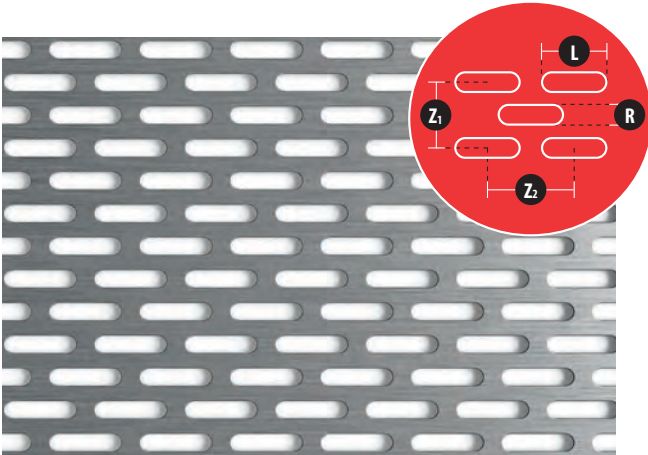

Kod Code	Delik Ölçüsü Hole Size	Merkezler Arası Mesafe Distance Between Centers	Sac Kalınlığı Sheet Thickness	Tabaka Ölçüsü Plate Dimension	Boşluk Oranı Open Area
	RxL	Z ₁ xZ ₂	S		
0785	2x20 mm	13x24 mm	1 mm	1000x2000 mm	%23
0786	3x20 mm	13x24 mm	1 mm	1000x2000 mm	%34
0787	5x20 mm	21x26 mm	1 mm	1000x2000 mm	%44
0788	8x20 mm	26x26 mm	1 mm	1000x2000 mm	%40
0789	10x20 mm	29x26 mm	1 mm	1000x2000 mm	%44

****Standart delikli saclarımız 1 mm kalınlığında olup, istenildiği takdirde 2 mm kalınlığa kadar üretim yapılabilir.**
 **Standard perforated sheet metal is 1 mm thickness, if requested can be produce it up to 2 mm thickness.

****Standart tabaka ölçüsü 1000x2000 mm olup, istenildiği takdirde 1250x2500 mm veya 1500x3000 mm olarak da üretilebilir.**
 **Standard sheet size is 1000x2000 mm, if requested can be produced in 1250x2500 mm or 1500x3000 mm sizes.

Dekoratif Delikli Saclar - Decorative Perforated Sheets

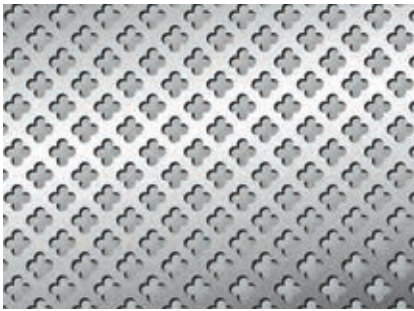

0790
1000x2000x1mm

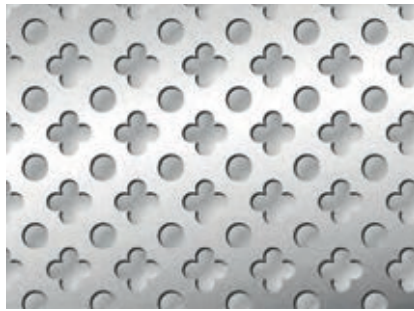

0791
1000x2000x1mm

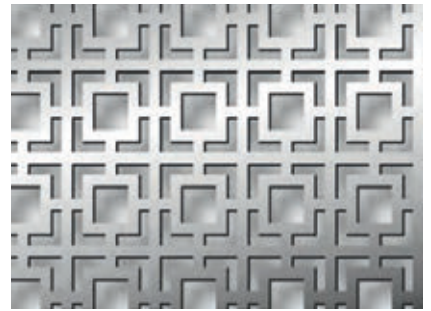

0793
1000x2000x1mm

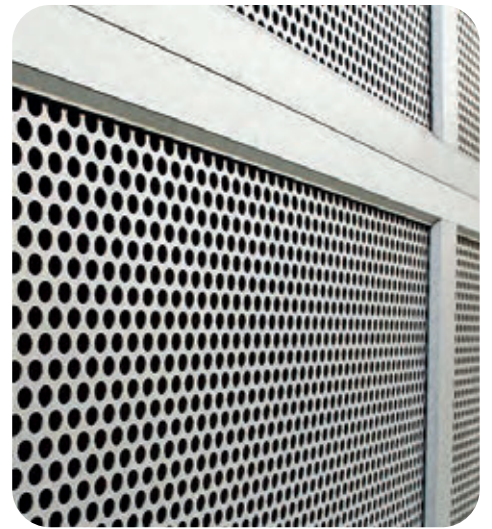

Desenli Saclar - Patterned Sheets

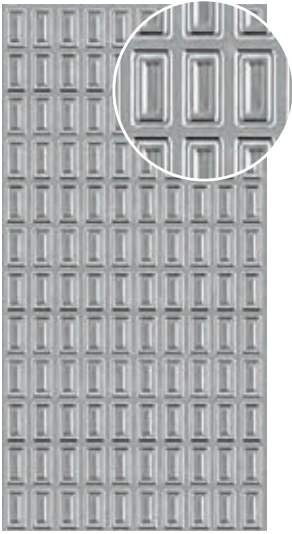

0600

1000x2000x1.1mm

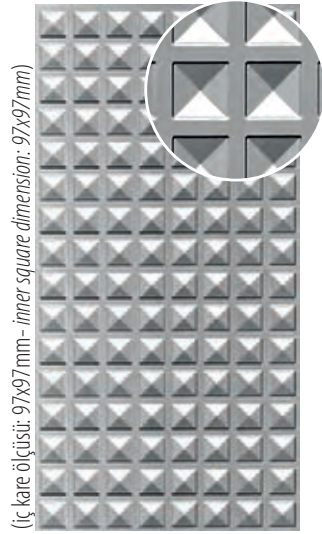

(iç kare ölçüsü: 97x97mm - inner square dimension: 97x97mm)

0601

1000x2000x1.1mm

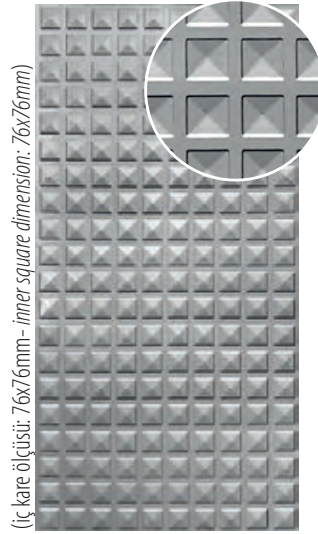

(iç kare ölçüsü: 76x76mm - inner square dimension: 76x76mm)

0601-A

1000x2000x1.1mm



0602

1000x2000x1.1mm



0603

1000x2000x1.1mm

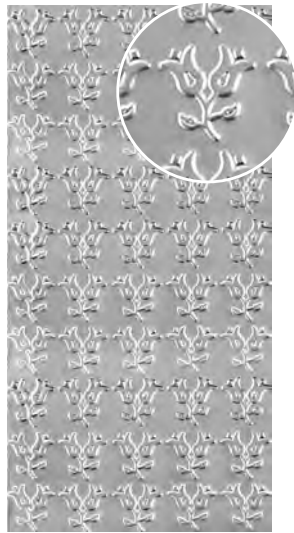

0604

1000x2000x1.1mm

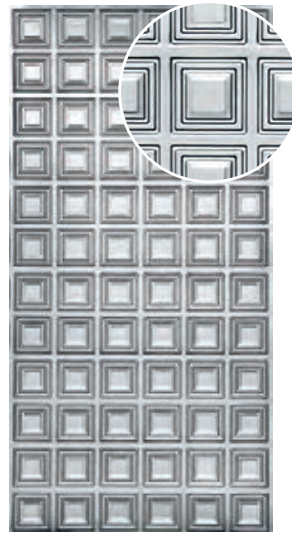

0605

1000x2000x1.1mm

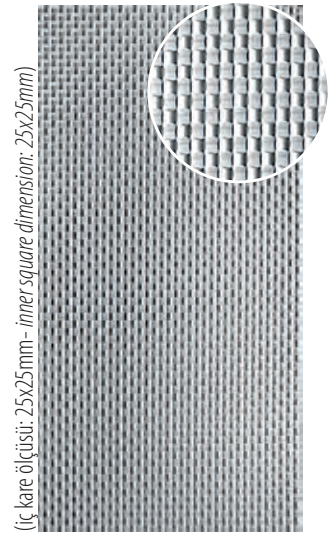

(iç kare ölçüsü: 25x25mm - inner square dimension: 25x25mm)

0606

1000x2000x1.1mm

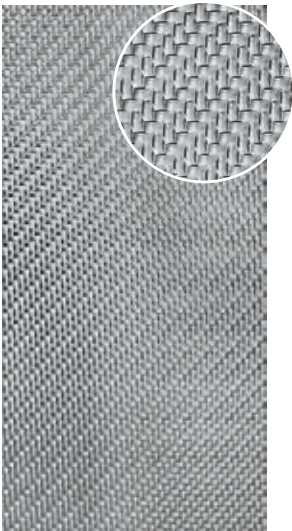

0607

1000x2000x1.1mm

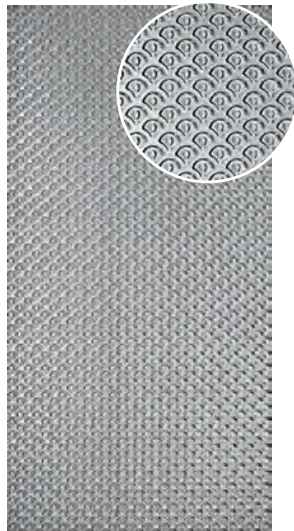

0608

1000x2000x1.1mm

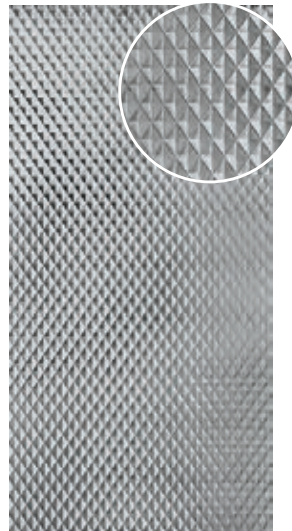

0609

1000x2000x1.1mm

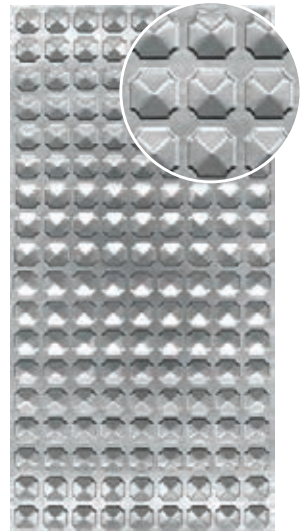

0610

1000x2000x1.1mm

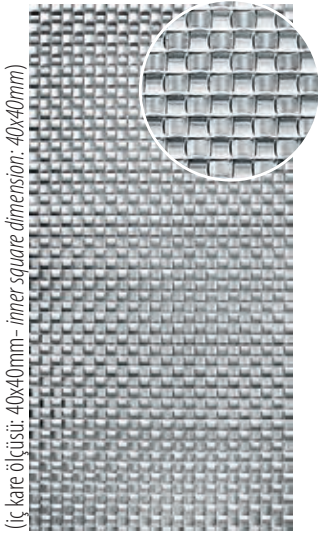

0611

1000x2000x1.1mm

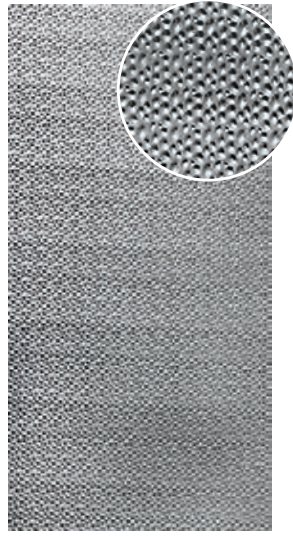

0612

1000x2000x1.1mm



0613

1000x2000x1.1mm



0614

1000x2000x1.1mm

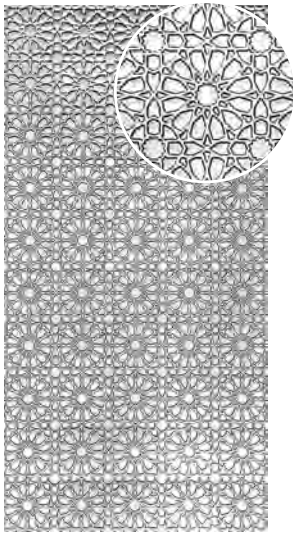

0615

1000x2000x1.1mm



0616

1000x2000x1.1mm



0617

1000x2000x1.1mm

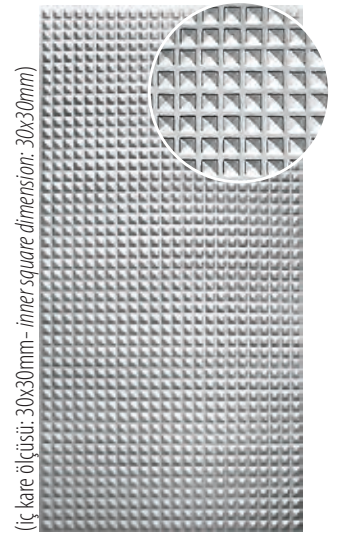

0618

1000x2000x1.1mm

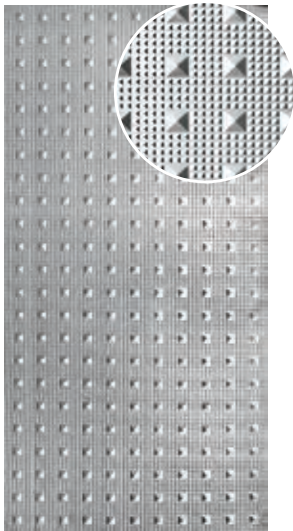

0619

1000x2000x1.1mm

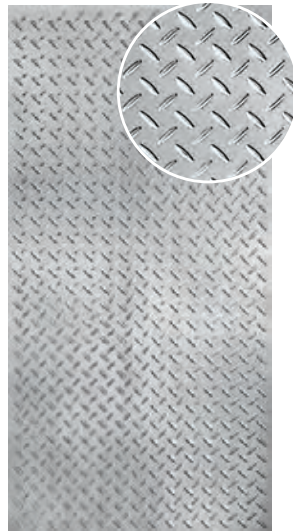

0620

1000x2000x1.1mm

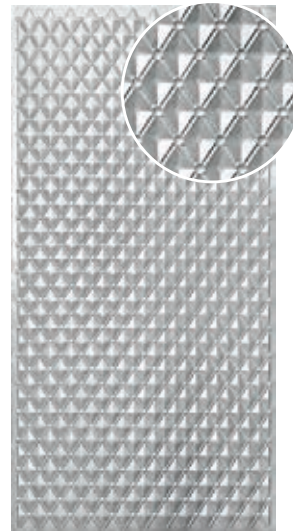

0621

1000x2000x1.1mm

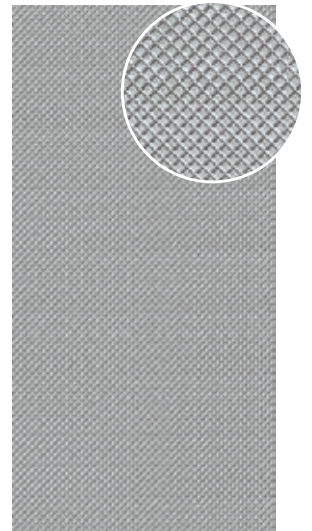

0622

1000x2000x1.0mm

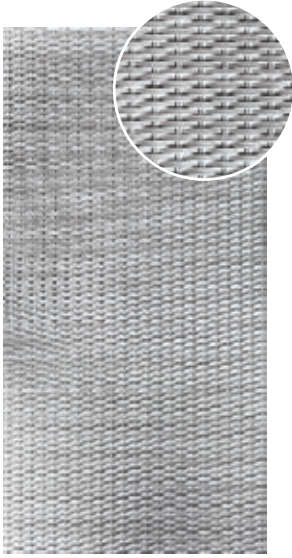

0623

1000x1980x0.8mm

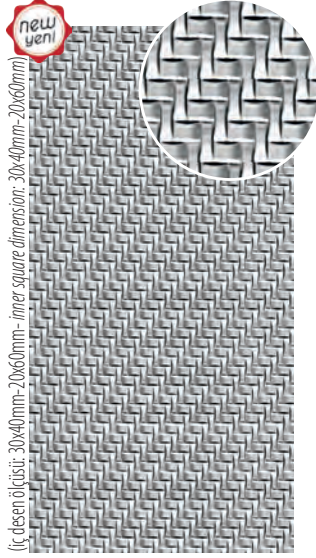

(iç desen ölçüsü: 30x40mm-20x60mm- inner square dimension: 30x40mm-20x60mm)

0624

1000x2040x1.1mm



0625

1000x2000x1.1mm

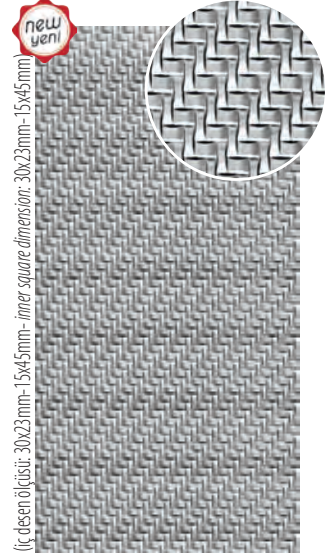

(iç desen ölçüsü: 30x23mm-15x45mm- inner square dimension: 30x23mm-15x45mm)

0626

1000x2000x1.1mm

****Standart sadarmız DKP sac olup, istenildiği takdirde galvanizli sactan da üretim yapılabilir.**

****Standard sheets are DKP sheet metal, production can also be made from galvanized sheet metal if requested.**

****Standart Sac Ölçüsü : 1000x2000x1.1mm (istenildiği takdirde 0.60 / 0.70 / 0.80 / 0.90 / 1.00 / 1.20 mm olarak da üretilebilir.)**

**** Standard Sheet Size: 1000x2000x1.1mm (can be produced as 0.60 / 0.70 / 0.80 / 0.90 / 1.00 / 1.20 mm if requested.)**



kod/code : 0601

kod/code : 0405

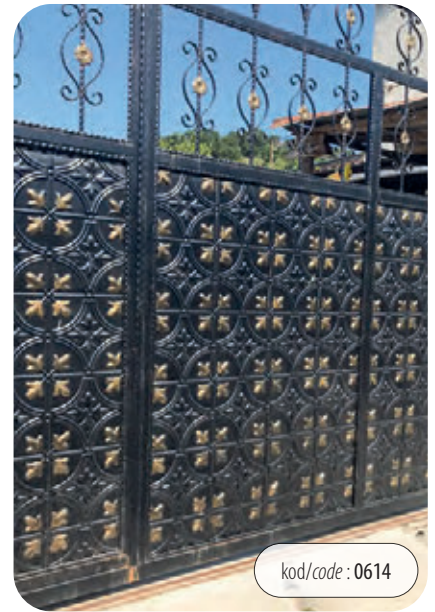

kod/code : 0614



kod/code : 0613



kod/code : 0611

Çelik Kapı Sacları - Metal Door Sheet

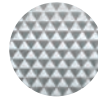

0500 serisi (baklava çerçevesi model)
0500 series (diamond frame model)

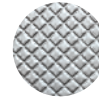

0500-A serisi (kare çerçevesi model)
0500-A series (square frame model)



0400

1000(520x1600)x2000x1mm



0401

1000(520x1600)x2000x1mm



0402

1000(520x1600)x2000x1mm



0403

1000(520x1600)x2000x1mm



0500

1000(520x1600)x2000x1mm



0501

1000(520x1600)x2000x1mm



0502

1000(520x1600)x2000x1mm



0503

1000(520x1600)x2000x1mm

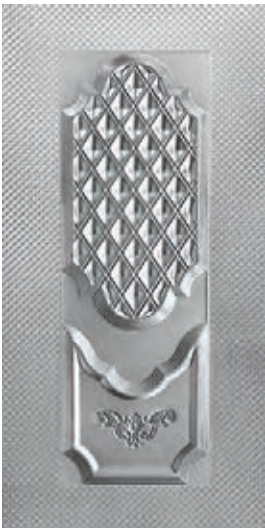

0500-A

1000(520x1600)x2000x1mm



0501-A

1000(520x1600)x2000x1mm



0502-A

1000(520x1600)x2000x1mm



0503-A

1000(520x1600)x2000x1mm

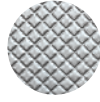
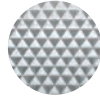

0404

1000(520x1600)x2000x1mm



0405

1000(520x1600)x2000x1mm



0406

1000(520x1600)x2000x1mm



0407

1000(520x1600)x2000x1mm



0504

1000(520x1600)x2000x1mm



0505

1000(520x1600)x2000x1mm



0506

1000(520x1600)x2000x1mm



0507

1000(520x1600)x2000x1mm



0504-A

1000(520x1600)x2000x1mm



0505-A

1000(520x1600)x2000x1mm



0506-A

1000(520x1600)x2000x1mm



0507-A

1000(520x1600)x2000x1mm

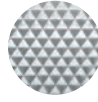

0500 serisi (baklava çerçevesi model)
0500 series (diamond frame model)



0500-A serisi (kare çerçevesi model)
0500-A series (square frame model)



0408

1000(520x1600)x2000x1mm



0409

1000(520x1600)x2000x1mm



0410

1000(520x1600)x2000x1mm



0411

1000(520x1600)x2000x1mm



0508

1000(520x1600)x2000x1mm



0509

1000(520x1600)x2000x1mm



0510

1000(520x1600)x2000x1mm



0511

1000(520x1600)x2000x1mm



0508-A

1000(520x1600)x2000x1mm



0509-A

1000(520x1600)x2000x1mm



0510-A

1000(520x1600)x2000x1mm



0511-A

1000(520x1600)x2000x1mm

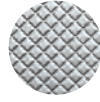
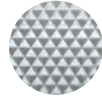

0412

1000(520x1600)x2000x1mm



0413

1000(520x1600)x2000x1mm



0414

1000(520x1600)x2000x1mm



0415

1000(520x1600)x2000x1mm

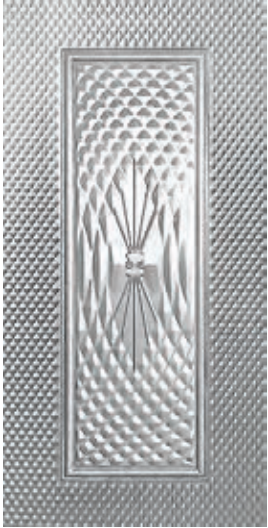

0512

1000(520x1600)x2000x1mm



0513

1000(520x1600)x2000x1mm



0514

1000(520x1600)x2000x1mm



0515

1000(520x1600)x2000x1mm



0512-A

1000(520x1600)x2000x1mm



0513-A

1000(520x1600)x2000x1mm



0514-A

1000(520x1600)x2000x1mm



0515-A

1000(520x1600)x2000x1mm

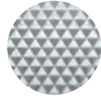

0500 serisi (baklava çerçevesi model)
0500 series (diamond frame model)



0500-A serisi (kare çerçevesi model)
0500-A series (square frame model)



0416

1000(520x1600)x2000x1mm



0417

1000(520x1600)x2000x1mm



0418

1000(520x1600)x2000x1mm



0419

1000(520x1600)x2000x1mm



0516

1000(520x1600)x2000x1mm



0517

1000(520x1600)x2000x1mm



0518

1000(520x1600)x2000x1mm



0519

1000(520x1600)x2000x1mm



0516-A

1000(520x1600)x2000x1mm



0517-A

1000(520x1600)x2000x1mm



0518-A

1000(520x1600)x2000x1mm



0519-A

1000(520x1600)x2000x1mm

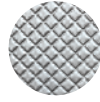
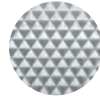

0420

1000(520x1600)x2000x1mm



0421

1000(520x1600)x2000x1mm



0422

1000(520x1600)x2000x1mm



0423

1000(520x1600)x2000x1mm

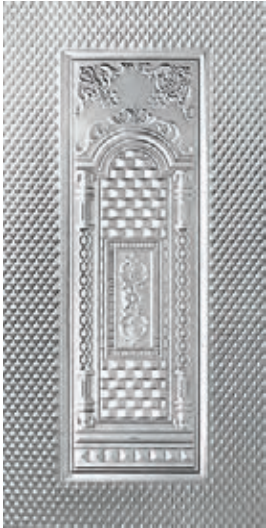

0520

1000(520x1600)x2000x1mm



0521

1000(520x1600)x2000x1mm



0522

1000(520x1600)x2000x1mm



0523

1000(520x1600)x2000x1mm

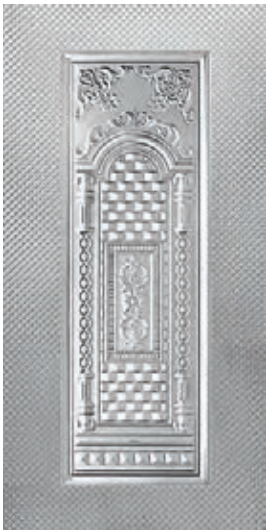

0520-A

1000(520x1600)x2000x1mm



0521-A

1000(520x1600)x2000x1mm



0522-A

1000(520x1600)x2000x1mm



0523-A

1000(520x1600)x2000x1mm

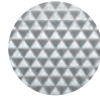

0500 serisi (baklava çerçevesi model)
0500 series (diamond frame model)

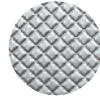

0500-A serisi (kare çerçevesi model)
0500-A series (square frame model)



0424

1000(520x1600)x2000x1mm



0425

1000(520x1600)x2000x1mm



0426

1000(520x1600)x2000x1mm



0427

1000(520x1600)x2000x1mm



0524

1000(520x1600)x2000x1mm



0525

1000(520x1600)x2000x1mm



0526

1000(520x1600)x2000x1mm



0527

1000(520x1600)x2000x1mm



0524-A

1000(520x1600)x2000x1mm



0525-A

1000(520x1600)x2000x1mm



0526-A

1000(520x1600)x2000x1mm



0527-A

1000(520x1600)x2000x1mm

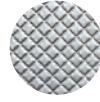
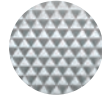

0428

1000(520x1600)x2000x1mm



0429

1000(520x1600)x2000x1mm



0430

1000(520x1600)x2000x1mm



0431

1000(520x1600)x2000x1mm



0528

1000(520x1600)x2000x1mm



0529

1000(520x1600)x2000x1mm



0530

1000(520x1600)x2000x1mm



0531

1000(520x1600)x2000x1mm



0528-A

1000(520x1600)x2000x1mm



0529-A

1000(520x1600)x2000x1mm



0530-A

1000(520x1600)x2000x1mm



0531-A

1000(520x1600)x2000x1mm

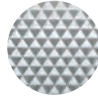

0500 serisi (baklava çerçevesi model)
0500 series (diamond frame model)



0500-A serisi (kare çerçevesi model)
0500-A series (square frame model)



0432

1000(520x1600)x2000x1mm



0433

1000(520x1600)x2000x1mm



0434

1000(520x1600)x2000x1mm



0435

1000(520x1600)x2000x1mm



0532

1000(520x1600)x2000x1mm



0533

1000(520x1600)x2000x1mm



0534

1000(520x1600)x2000x1mm



0535

1000(520x1600)x2000x1mm



0532-A

1000(520x1600)x2000x1mm



0533-A

1000(520x1600)x2000x1mm



0534-A

1000(520x1600)x2000x1mm



0535-A

1000(520x1600)x2000x1mm

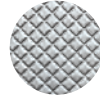
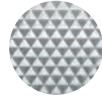

0436

1000(520x1600)x2000x1mm



0437

1000(520x1600)x2000x1mm



0438

1000(520x1600)x2000x1mm



0439

1000(520x1600)x2000x1mm



0536

1000(520x1600)x2000x1mm



0537

1000(520x1600)x2000x1mm



0538

1000(520x1600)x2000x1mm



0539

1000(520x1600)x2000x1mm



0536-A

1000(520x1600)x2000x1mm



0537-A

1000(520x1600)x2000x1mm



0538-A

1000(520x1600)x2000x1mm



0539-A

1000(520x1600)x2000x1mm

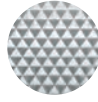

0500 serisi (baklava çerçevesi model)
0500 series (diamond frame model)

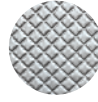

0500-A serisi (kare çerçevesi model)
0500-A series (square frame model)



0440

1000(520x1600)x2000x1mm



0441

1000(520x1600)x2000x1mm



0442

1000(520x1600)x2000x1mm



0443

1000(520x1600)x2000x1mm



0540

1000(520x1600)x2000x1mm



0541

1000(520x1600)x2000x1mm



0542

1000(520x1600)x2000x1mm

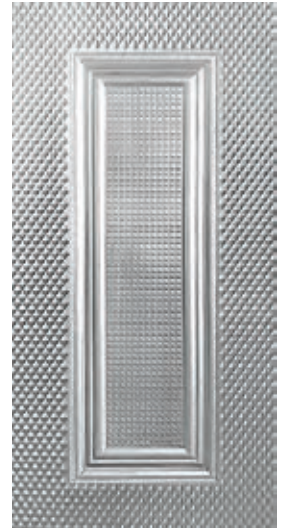

0543

1000(520x1600)x2000x1mm



0540-A

1000(520x1600)x2000x1mm



0541-A

1000(520x1600)x2000x1mm



0542-A

1000(520x1600)x2000x1mm



0543-A

1000(520x1600)x2000x1mm

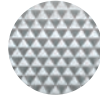

0444

1000(520x1600)x2000x1mm



0445

1000(520x1600)x2000x1mm



0446

1000(520x1600)x2000x1mm



0447

1000(520x1600)x2000x1mm



0544

1000(520x1600)x2000x1mm



0545

1000(520x1600)x2000x1mm



0546

1000(520x1600)x2000x1mm



0547

1000(520x1600)x2000x1mm



0544-A

1000(520x1600)x2000x1mm



0545-A

1000(520x1600)x2000x1mm



0546-A

1000(520x1600)x2000x1mm



0547-A

1000(520x1600)x2000x1mm

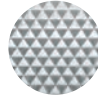

0500 serisi (baklava çerçevesi model)
0500 series (diamond frame model)

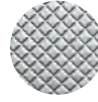

0500-A serisi (kare çerçevesi model)
0500-A series (square frame model)



0448

1000(520x1600)x2000x1mm



0449

1000(520x1600)x2000x1mm



0450

1000(520x1600)x2000x1mm



0451

1000(520x1600)x2000x1mm



0548

1000(520x1600)x2000x1mm



0549

1000(520x1600)x2000x1mm



0550

1000(520x1600)x2000x1mm



0551

1000(520x1600)x2000x1mm



0548-A

1000(520x1600)x2000x1mm



0549-A

1000(520x1600)x2000x1mm



0550-A

1000(520x1600)x2000x1mm



0551-A

1000(520x1600)x2000x1mm

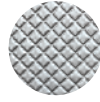
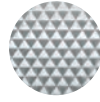

0452

1000(520x1600)x2000x1mm



0453

1000(520x1600)x2000x1mm



0454

1000(520x1600)x2000x1mm



0455

1000(520x1600)x2000x1mm



0552

1000(520x1600)x2000x1mm



0553

1000(520x1600)x2000x1mm



0554

1000(520x1600)x2000x1mm



0555

1000(520x1600)x2000x1mm



0552-A

1000(520x1600)x2000x1mm



0553-A

1000(520x1600)x2000x1mm



0554-A

1000(520x1600)x2000x1mm



0555-A

1000(520x1600)x2000x1mm

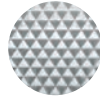

0500 serisi (baklava çerçevesi model)
0500 series (diamond frame model)

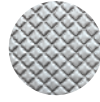

0500-A serisi (kare çerçevesi model)
0500-A series (square frame model)



0456

1000(520x1600)x2000x1mm



0457

1000(520x1600)x2000x1mm



0458

1000(520x1600)x2000x1mm



0459

1000(520x1600)x2000x1mm



0556

1000(520x1600)x2000x1mm

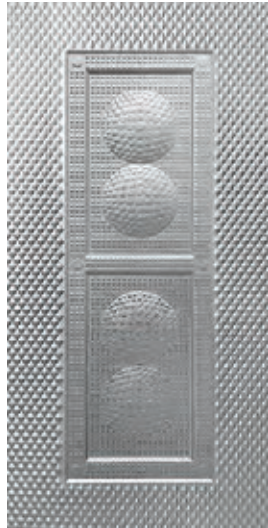

0557

1000(520x1600)x2000x1mm



0558

1000(520x1600)x2000x1mm



0559

1000(520x1600)x2000x1mm



0556-A

1000(520x1600)x2000x1mm



0557-A

1000(520x1600)x2000x1mm



0558-A

1000(520x1600)x2000x1mm



0559-A

1000(520x1600)x2000x1mm

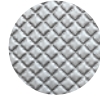
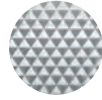

0460

1000(520x1600)x2000x1mm



0461

1000(520x1600)x2000x1mm



0462

1000(520x1600)x2000x1mm



0463

1000(520x1600)x2000x1mm



0560

1000(520x1600)x2000x1mm



0561

1000(520x1600)x2000x1mm



0562

1000(520x1600)x2000x1mm



0563

1000(520x1600)x2000x1mm



0560-A

1000(520x1600)x2000x1mm



0561-A

1000(520x1600)x2000x1mm



0562-A

1000(520x1600)x2000x1mm



0563-A

1000(520x1600)x2000x1mm

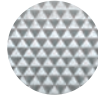

0500 serisi (baklava çerçevesi model)
0500 series (diamond frame model)



0500-A serisi (kare çerçevesi model)
0500-A series (square frame model)



0464

1000(520x1600)x2000x1mm



0465

1000(520x1600)x2000x1mm



0466

1000(520x1600)x2000x1mm



0467

1000(520x1600)x2000x1mm



0564

1000(520x1600)x2000x1mm



0565

1000(520x1600)x2000x1mm



0566

1000(520x1600)x2000x1mm



0567

1000(520x1600)x2000x1mm



0564-A

1000(520x1600)x2000x1mm



0565-A

1000(520x1600)x2000x1mm



0566-A

1000(520x1600)x2000x1mm



0567-A

1000(520x1600)x2000x1mm

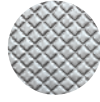
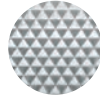

0468

1000(520x1600)x2000x1mm



0469

1000(520x1600)x2000x1mm



0470

1000(520x1600)x2000x1mm



0471

1000(520x1600)x2000x1mm



0568

1000(520x1600)x2000x1mm



0569

1000(520x1600)x2000x1mm



0570

1000(520x1600)x2000x1mm



0571

1000(520x1600)x2000x1mm



0568-A

1000(520x1600)x2000x1mm



0569-A

1000(520x1600)x2000x1mm



0570-A

1000(520x1600)x2000x1mm



0571-A

1000(520x1600)x2000x1mm

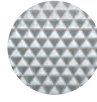

0500 serisi (baklava çerçevesi model)
0500 series (diamond frame model)



0500-A serisi (kare çerçevesi model)
0500-A series (square frame model)



0472

1000(520x1600)x2000x1mm



0473

1000(520x1600)x2000x1mm



0474

1000(520x1600)x2000x1mm



0475

1000(520x1600)x2000x1mm



0572

1000(520x1600)x2000x1mm



0573

1000(520x1600)x2000x1mm



0574

1000(520x1600)x2000x1mm



0575

1000(520x1600)x2000x1mm



0572-A

1000(520x1600)x2000x1mm



0573-A

1000(520x1600)x2000x1mm



0574-A

1000(520x1600)x2000x1mm



0575-A

1000(520x1600)x2000x1mm

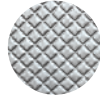
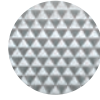

0476

1000(520x1600)x2000x1mm



0477

1000(520x1600)x2000x1mm



04751

1000(520x1600)x2000x1mm



04752

1000(520x1600)x2000x1mm

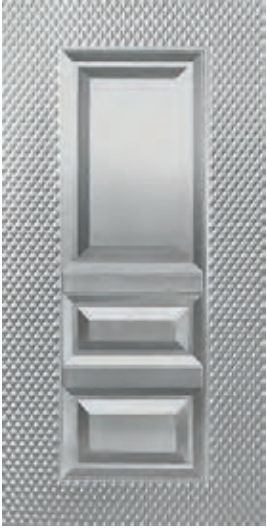

0576

1000(520x1600)x2000x1mm



0577

1000(520x1600)x2000x1mm



05751

1000(520x1600)x2000x1mm



05752

1000(520x1600)x2000x1mm



0576-A

1000(520x1600)x2000x1mm



0577-A

1000(520x1600)x2000x1mm



05751-A

1000(520x1600)x2000x1mm



05752-A

1000(520x1600)x2000x1mm

**Standart saclarımız DKP sac olup, istenildiği takdirde galvanizli sacdan da üretim yapılabilir.

**Standard sheets are DKP sheet metal, production can also be made from galvanized sheet metal if requested.

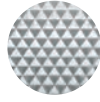

0500 serisi (baklava çerçevesi model)
0500 series (diamond frame model)

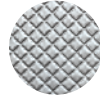

0500-A serisi (kare çerçevesi model)
0500-A series (square frame model)



kod/code : 0450



04753

1000(520x1600)x2000x1mm



04754

1000(520x1600)x2000x1mm



04755

1000(520x1600)x2000x1mm



kod/code : 0447



05753

1000(520x1600)x2000x1mm



05754

1000(520x1600)x2000x1mm



05755

1000(520x1600)x2000x1mm



kod/code : 0473



05753-A

1000(520x1600)x2000x1mm



05754-A

1000(520x1600)x2000x1mm



05755-A

1000(520x1600)x2000x1mm

**Standart Sac Ölçüsü : 1000x2000x1mm olup, istenildiği takdirde 0.60 / 0.70 / 0.80 / 0.90 mm olarak da üretilebilir.
**Standard Sheet Size: 1000x2000x1mm also can be produced as 0.60 / 0.70 / 0.80 / 0.90mm if requested.



0478

500(220x1600)x2000x0.90mm



0478-A

500(220x1600)x2000x0.90mm



0479

500(220x1600)x2000x0.90mm



0479-A

500(220x1600)x2000x0.90mm



0480

500(220x1600)x2000x0.90mm



0480-A

500(220x1600)x2000x0.90mm



0481

500(220x1600)x2000x0.90mm



0481-A

500(220x1600)x2000x0.90mm



0482

500(220x1600)x2000x0.90mm



0482-A

500(220x1600)x2000x0.90mm



0483

500(220x1600)x2000x0.90mm



0483-A

500(220x1600)x2000x0.90mm

****500x2000 mm ve 1000x1000 mm kapı saclarımız standart olarak 0.90 mm kalınlıkta üretilmektedir.**
****500x2000mm and 1000x1000 mm door sheets are produced with a standard thickness of 0.90 mm.**



0484

500(220x1600)x2000x0.90mm



0484-A

500(220x1600)x2000x0.90mm



0485

500(220x1600)x2000x0.90mm



0485-A

500(220x1600)x2000x0.90mm



0486

500(220x1600)x2000x0.90mm



0486-A

500(220x1600)x2000x0.90mm



0487

500(220x1600)x2000x0.90mm



0487-A

500(220x1600)x2000x0.90mm



0488

500(220x1600)x2000x0.90mm



0488-A

500(220x1600)x2000x0.90mm



0489

500(220x1600)x2000x0.90mm



0489-A

500(220x1600)x2000x0.90mm

**500x2000 mm ve 1000x1000 mm kapı saclarımız standart olarak 0.90 mm kalınlıkta üretilmektedir.
**500x2000mm and 1000x1000 mm door sheets are produced with a standard thickness of 0.90 mm.



04851

500(220x1600)x2000x0.90mm



04851-A

500(220x1600)x2000x0.90mm



04852

500(220x1600)x2000x0.90mm



04852-A

500(220x1600)x2000x0.90mm



04853

500(220x1600)x2000x0.90mm



04853-A

500(220x1600)x2000x0.90mm

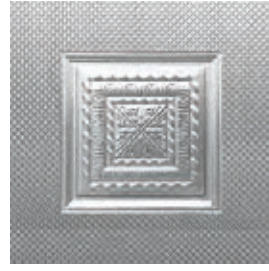

0490-A

1000(520x520)x1000x0.90mm



0491-A

1000(520x520)x1000x0.90mm



0492-A

1000(520x520)x1000x0.90mm



0493-A

1000(520x520)x1000x0.90mm



0494-A

1000(520x520)x1000x0.90mm



0495-A

1000(520x520)x1000x0.90mm



0496-A

1000(520x520)x1000x0.90mm



0497-A

1000(520x520)x1000x0.90mm



0498-A

1000(520x520)x1000x0.90mm



0499-A

1000(520x520)x1000x0.90mm

****500x2000 mm ve 1000x1000 mm kapı saclarımız standart olarak 0.90 mm kalınlıkta üretilmektedir.**

****500x2000mm and 1000x1000 mm door sheets are produced with a standard thickness of 0.90 mm.**

Hazır Demir Kapılar - Ready to Installation Iron Doors



ön yüz/front side



arka yüz/back side

Kod Code	Genişlik Width	Yükseklik Height
HK-0526-A	990 mm	1960 mm
<p>***Hazır kapılarda 0.80mm kalınlığında kapı sacı, 40x40x1mm profil, 20x5mm izli lama, Ø14'lük menteşe kullanılmaktadır. ***Doors are produced with combination of 0.80mm thickness door sheet, 40x40x1mm profile, 20x5mm hammered flat bar, and Ø14mm hinges.</p> <p>***Tüm hazır kapı modelleri; siyah veya beyaz boyalı olarak, kilit dahil olmak üzere eksiksiz bir set halindedir ve kurulumu hazırdır. ***All door models are painted (black or white), as a complete set including the lock, and ready for installation.</p> <p>***Kataloğumuzda bulunan tüm kapı sacı modellerinden hazır kapı yapılabilir. ***Doors can be produced from all steel door sheets models in our catalog.</p> <p>***Uygun fiyatlı olması sebebiyle, kırsal bölgelerdeki bahçe kapılarında ve inşaat alanlarında kurulan geçici şantiyelerde çokça tercih edilmektedir. ***Due to its low price, it is frequently preferred for garden gates in rural areas and for temporary construction sites at building areas.</p>		



ön yüz/front side



arka yüz/back side

Kod Code	Genişlik Width	Yükseklik Height
HK-0540-A	990 mm	1960 mm
<p>***Hazır kapılarda 0.80mm kalınlığında kapı sacı, 40x40x1mm profil, 20x5mm izli lama, Ø14'lük menteşe kullanılmaktadır. ***Doors are produced with combination of 0.80mm thickness door sheet, 40x40x1mm profile, 20x5mm hammered flat bar, and Ø14mm hinges.</p> <p>***Tüm hazır kapı modelleri; siyah veya beyaz boyalı olarak, kilit dahil olmak üzere eksiksiz bir set halindedir ve kurulumu hazırdır. ***All door models are painted (black or white), as a complete set including the lock, and ready for installation.</p> <p>***Kataloğumuzda bulunan tüm kapı sacı modellerinden hazır kapı yapılabilir. ***Doors can be produced from all steel door sheets models in our catalog.</p> <p>***Uygun fiyatlı olması sebebiyle, kırsal bölgelerdeki bahçe kapılarında ve inşaat alanlarında kurulan geçici şantiyelerde çokça tercih edilmektedir. ***Due to its low price, it is frequently preferred for garden gates in rural areas and for temporary construction sites at building areas.</p>		

İzli ve Desenli Lamalar- Decorative Patterned Flat Bars



Kod Code	Ölçü Dimension	Uzunluk Length	Ağırlık Weight
2201	25x5 mm	6000 mm	5.88 kg
2202	30x5 mm	6000 mm	7.08 kg
2203	40x5 mm	6000 mm	9.42 kg



Kod Code	Ölçü Dimension	Uzunluk Length	Ağırlık Weight
2221	25x5 mm	6000 mm	5.88 kg
2222	30x5 mm	6000 mm	7.08 kg
2223	40x5 mm	6000 mm	9.42 kg

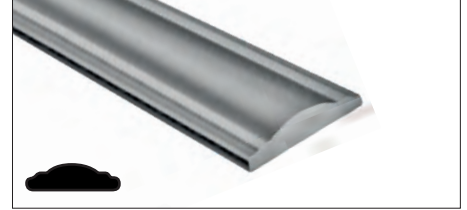

Kod Code	Ölçü Dimension	Uzunluk Length	Ağırlık Weight
2231	40x11 mm	6000 mm	15.60 kg
2232	50x14 mm	6000 mm	22.86 kg



Kod Code	Ölçü Dimension	Uzunluk Length	Ağırlık Weight
2217	20x10 mm	6000 mm	9.42 kg
2218	25x10 mm	6000 mm	11.79 kg
2219	30x10 mm	6000 mm	14.16 kg
2220	40x10 mm	6000 mm	18.84 kg
2229	50x10 mm	6000 mm	23.58 kg

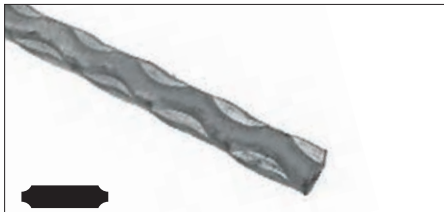

Kod Code	Ölçü Dimension	Uzunluk Length	Ağırlık Weight
2268	12x6 mm	6000 mm	3.40 kg
2269	14x6 mm	6000 mm	3.96 kg
2271	16x7 mm	6000 mm	5.30 kg

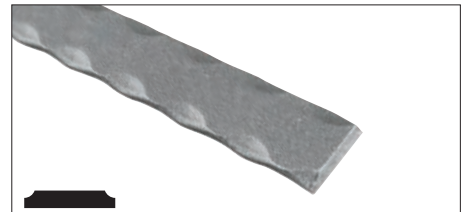

Kod Code	Ölçü Dimension	Uzunluk Length	Ağırlık Weight
2279	20x5 mm	6000 mm	4.70 kg
2280	25x5 mm	6000 mm	5.88 kg
2281	30x5 mm	6000 mm	7.08 kg
2282	40x5 mm	6000 mm	9.42 kg
2283	50x5 mm	6000 mm	11.79 kg

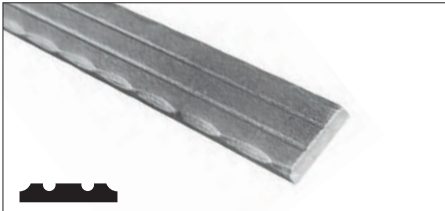

Kod Code	Ölçü Dimension	Uzunluk Length	Ağırlık Weight
2272	25x5 mm	6000 mm	5.88 kg
2273	30x5 mm	6000 mm	7.08 kg
2274	40x5 mm	6000 mm	9.42 kg
2275	50x5 mm	6000 mm	11.79 kg

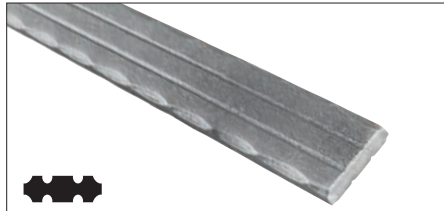

Kod Code	Ölçü Dimension	Uzunluk Length	Ağırlık Weight
2276	25x10 mm	6000 mm	11.79 kg
2277	30x10 mm	6000 mm	14.16 kg
2278	40x10 mm	6000 mm	18.84 kg

T-Z-L Profiller - T-Z-L Shaped Profiles

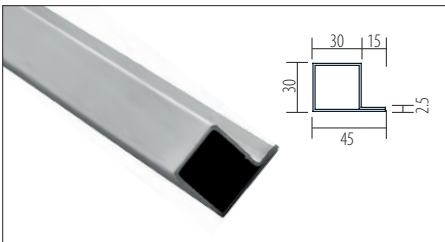

Kod Code	Ölçü Dimension	Uzunluk Length	Ağırlık Weight
2300	30x45x30 mm	6000 mm	9.50 kg

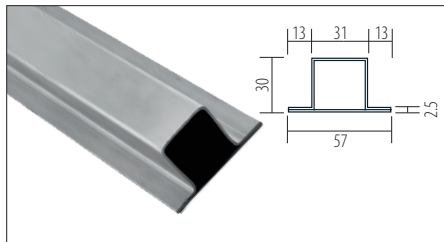

Kod Code	Ölçü Dimension	Uzunluk Length	Ağırlık Weight
2302	30x57x31 mm	6000 mm	11.00 kg

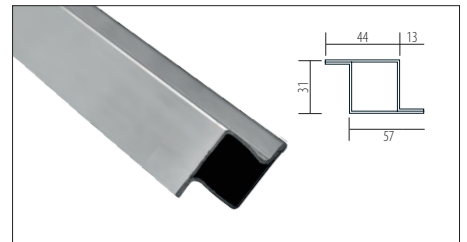

Kod Code	Ölçü Dimension	Uzunluk Length	Ağırlık Weight
2304	31x44x30 mm	6000 mm	11.00 kg

Burgulu ve İzli Kareler & Lamalar- Decorative Flat Bars



Kod Code	Ölçü Dimension	Uzunluk Length	Ağırlık Weight
2200-A	10x10 mm	6000 mm	4.71 kg
2200-B	12x12 mm	6000 mm	6.78 kg



Kod Code	Ölçü Dimension	Uzunluk Length	Ağırlık Weight
2211-B	10x10 mm	6000 mm	4.71 kg
2211-A	11x11 mm	6000 mm	5.69 kg
2211-C	11.5x11.5 mm	6000 mm	6.22 kg
2211	12x12 mm	6000 mm	6.78 kg
2212	14x14 mm	6000 mm	9.24 kg
2213	16x16 mm	6000 mm	12.06 kg
2214	20x20 mm	6000 mm	18.84 kg

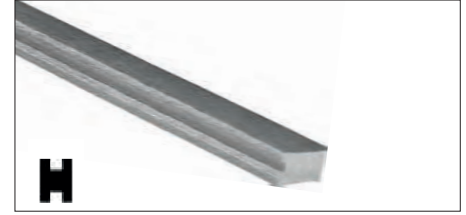

Kod Code	Ölçü Dimension	Uzunluk Length	Ağırlık Weight
2284	12x6 mm	6000 mm	3.40 kg
2287	16x7 mm	6000 mm	5.30 kg

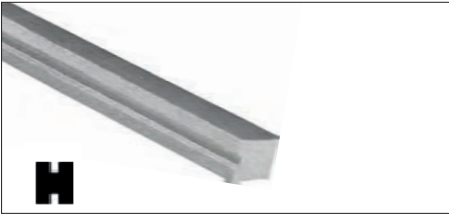

Kod Code	Ölçü Dimension	Uzunluk Length	Ağırlık Weight
2288	12x12 mm	6000 mm	6.78 kg
2289	14x14 mm	6000 mm	9.24 kg
2290	16x16 mm	6000 mm	12.06 kg

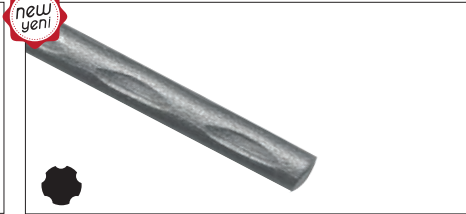

Kod Code	Ölçü Dimension	Uzunluk Length	Ağırlık Weight
2299	Ø 12 mm	6000 mm	5.33 kg

İzli ve Desenli Profiller- Decorative Profiles



Kod Code	Ölçü Dimension	Uzunluk Length	Ağırlık Weight
2233	15x15x1.5 mm	6000 mm	3.60 kg
2234-A	20x20x1.5 mm	6000 mm	4.75 kg
2234	20x20x2 mm	6000 mm	6.00 kg
2235	25x25x1.5 mm	6000 mm	6.00 kg
2235-A	25x25x2 mm	6000 mm	7.50 kg
2236-A	30x30x1.5mm	6000 mm	7.35 kg
2236	30x30x2 mm	6000 mm	9.50 kg
2237-A	40x40x1.5 mm	6000 mm	9.40 kg
2237	40x40x2 mm	6000 mm	12.50 kg
2238-A	50x50x1.5 mm	6000 mm	12.00 kg
2238	50x50x2 mm	6000 mm	15.60 kg
2239-A	60x60x1.5mm	6000 mm	14.50 kg
2239	60x60x2 mm	6000 mm	19.35 kg



Kod Code	Ölçü Dimension	Uzunluk Length	Ağırlık Weight
2246	10x20x1.5 mm	6000 mm	3.60 kg
2246-A	10x40x1.5mm	6000 mm	6.00 kg
2247-A	20x30x1.5 mm	6000 mm	6.00 kg
2247	20x30x2 mm	6000 mm	7.50 kg
2248-A	20x40x1.5 mm	6000 mm	7.35 kg
2248	20x40x2 mm	6000 mm	9.50 kg
2249	30x40x2 mm	6000 mm	11.05 kg
2250	30x50x2 mm	6000 mm	12.50 kg
2252	40x60x2 mm	6000 mm	15.60 kg
2253	40x80x2 mm	6000 mm	19.35 kg



Kod Code	Ölçü Dimension	Uzunluk Length	Ağırlık Weight
2391-A	10x40x1.5mm	6000 mm	6.00 kg
2260-A	20x20x1.5 mm	6000 mm	4.75 kg
2391	20x20x2 mm	6000 mm	6.00 kg
2260-B	25x25x1.5 mm	6000 mm	6.00 kg
2392	25x25x2 mm	6000 mm	7.50 kg
2393	30x30x1.5 mm	6000 mm	7.35 kg
2260	30x30x2 mm	6000 mm	9.50 kg
2261-C	40x40x1.5 mm	6000 mm	9.40 kg
2261	40x40x2 mm	6000 mm	12.50 kg
2261-D	50x50x1.5 mm	6000 mm	12.00 kg
2261-A	50x50x2 mm	6000 mm	15.60 kg
2261-E	60x60x1.5 mm	6000 mm	14.50 kg
2261-B	60x60x2 mm	6000 mm	19.35 kg



Kod Code	Ölçü Dimension	Uzunluk Length	Ağırlık Weight
2240-A	10x30x1.5 mm	6000 mm	4.75 kg
2240-B	20x30x1.5mm	6000 mm	6.00 kg
2240	20x30x2 mm	6000 mm	7.50 kg
2241-A	20x40x1.5 mm	6000 mm	7.35 kg
2241	20x40x2 mm	6000 mm	9.50 kg
2242	30x40x2 mm	6000 mm	11.05 kg
2243	40x60x2 mm	6000 mm	15.60 kg
2243-A	40x80x2 mm	6000 mm	19.38 kg



Kod Code	Ölçü Dimension	Uzunluk Length	Ağırlık Weight
2293	30x30x2 mm	6000 mm	9.50 kg
2294	40x40x2 mm	6000 mm	12.50 kg



Kod Code	Ölçü Dimension	Uzunluk Length	Ağırlık Weight
2293-A	30x30x2 mm	6000 mm	9.50 kg
2294-A	40x40x2 mm	6000 mm	12.50 kg
2294-B	30x40x2 mm	6000 mm	11.05 kg

Düz ve Desenli Küpeştelere - Decorative Handrails



Kod Code	Ölçü Dimension	Uzunluk Length	Ağırlık Weight
2254	24x48x1.5 mm	6000 mm	7.32 kg
2255	30x62x1.5 mm	6000 mm	9.50 kg
2292	28x70x1.5 mm	6000 mm	11.90 kg



Kod Code	Ölçü Dimension	Uzunluk Length	Ağırlık Weight
2257	24x48x1.5 mm	6000 mm	7.32 kg
2258	30x62x1.5 mm	6000 mm	9.50 kg
2264	28x70x1.5 mm	6000 mm	11.90 kg

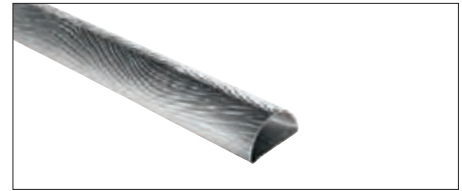

Kod Code	Ölçü Dimension	Uzunluk Length	Ağırlık Weight
2262	24x48x1.5 mm	6000 mm	7.32 kg
2263	30x62x1.5 mm	6000 mm	9.50 kg
2259	28x70x1.5 mm	6000 mm	11.90 kg



Kod Code	Ölçü Dimension	Uzunluk Length	Ağırlık Weight
2244	54x54x1.5 mm	6000 mm	12.20 kg



Kod Code	Ölçü Dimension	Uzunluk Length	Ağırlık Weight
2245	54x54x1.5 mm	6000 mm	12.20 kg



Kod Code	Ölçü Dimension	Uzunluk Length	Ağırlık Weight
2256	54x54x1.5 mm	6000 mm	12.20 kg

Alüminyum Döküm Küpeşte Kapakları - Aluminium Cast Handrail Lids



2265
45x20x40 mm
alüminyum döküm
(aluminium cast)
0.060 kg

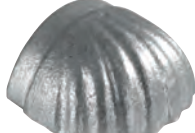

2266
60x30x50 mm
alüminyum döküm
(aluminium cast)
0.100 kg



2267
54x54x36 mm
alüminyum döküm
(aluminium cast)
0.120 kg

Kare Boğumlu Nervürlü Borular- Square Gnarled Ribbed Pipes

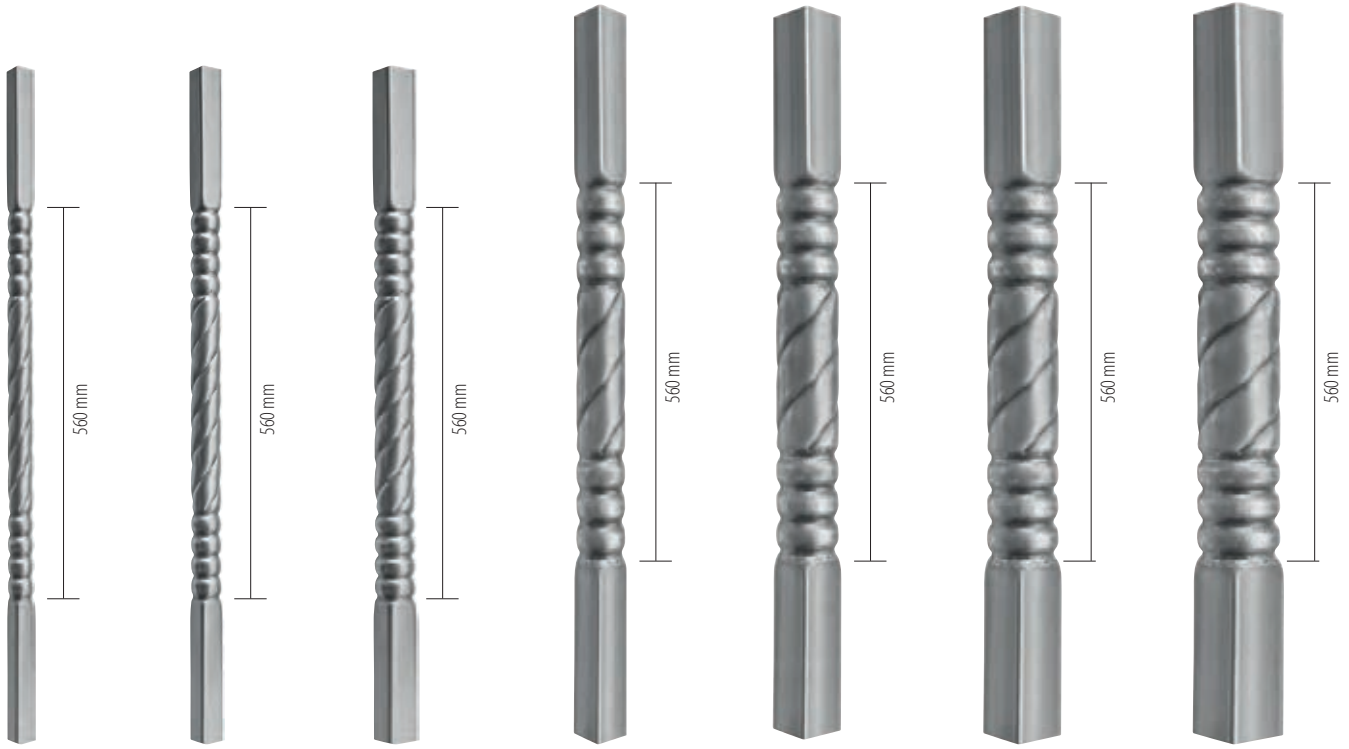

2001 1.0 mm □ 25x25 mm 1000 mm	2002 1.0 mm □ 30x30 mm 1000 mm	2003 1.2 mm □ 40x40 mm 1000 mm	2004 1.2 mm □ 47x47 mm 1200 mm	2005 1.5 mm □ 60x60 mm 1200 mm	2006 2.0 mm □ 70x70 mm 1200 mm	2007 2.0 mm □ 80x80 mm 1200 mm
--	--	--	--	--	--	--

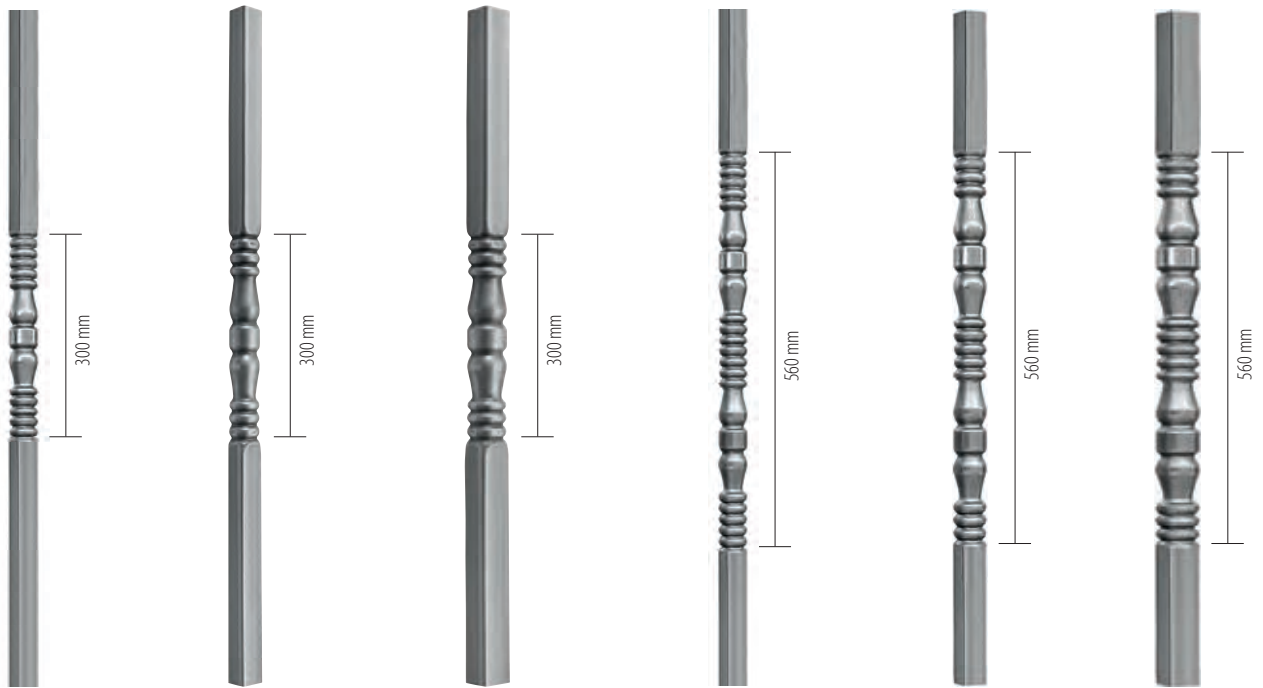

2009 1.0 mm □ 25x25 mm 1000 mm	2010 1.0 mm □ 30x30 mm 1000 mm	2011 1.2 mm □ 40x40 mm 1000 mm	2013 1.0 mm □ 25x25 mm 1000 mm	2014 1.0 mm □ 30x30 mm 1000 mm	2015 1.2 mm □ 40x40 mm 1000 mm
--	--	--	--	--	--

Yuvarlak Boğumlu Borular- Round Gnarled Pipes



2016
1.0 mm
Ø 28 mm
1000 mm



2017
1.0 mm
Ø 32 mm
1000 mm



2018
1.0 mm
Ø 38 mm
1000 mm



2019
1.2 mm
Ø 42 mm
1000 mm



2020
1.2 mm
Ø 48 mm
1000 mm



2021
1.2 mm
Ø 51 mm
1000 mm



2022
1.0 mm
Ø 28 mm
1000 mm

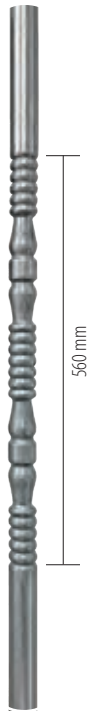

2023
1.0 mm
Ø 32 mm
1000 mm



2024
1.0 mm
Ø 38 mm
1000 mm



2025
1.2 mm
Ø 42 mm
1000 mm



2026
1.2 mm
Ø 48 mm
1000 mm







2027
1.2 mm
Ø 51 mm
1000 mm

****Yuvarlak boğumlu borular 6 metre uzunluğa kadar üretilebilir.**
****Round gnarled pipes can be produced in lengths of up to 6 meters.**

Konik / Kare / Yuvarlak Boğumlu Borular - Conical / Square / Round Gnarled Pipes

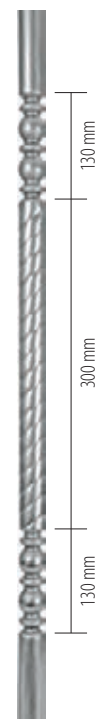
 <p>Ø15 mm CONICAL KONİK 130 mm Ø15 mm</p>	 <p>Ø15 mm CONICAL KONİK 160 mm Ø15 mm</p>	 <p>Ø15 mm CONICAL KONİK 160 mm Ø15 mm</p>	 <p>Ø15 mm CONICAL KONİK 300 mm Ø15 mm</p>	 <p>130 mm 1.2 mm □ 25x25 mm 900 mm</p>	 <p>160 mm 1.2 mm □ 25x25 mm 900 mm</p>
<p>2028 1.2 mm Ø 32 mm 900 mm</p>	<p>2031 1.2 mm Ø 32 mm 900 mm</p>	<p>2044 1.2 mm Ø 32 mm 900 mm</p>	<p>2045 1.2 mm Ø 32 mm 900 mm</p>	<p>2030 1.2 mm □ 25x25 mm 900 mm</p>	<p>2033 1.2 mm □ 25x25 mm 900 mm</p>

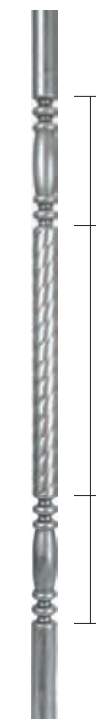
 <p>130 mm 1.2 mm Ø 32 mm 900 mm</p>	 <p>130 mm 1.2 mm Ø 32 mm 900 mm</p>	 <p>130 mm 300 mm 130 mm 1.2 mm Ø 32 mm 900 mm</p>	 <p>160 mm 1.2 mm Ø 32 mm 900 mm</p>	 <p>160 mm 240 mm 160 mm 1.2 mm Ø 32 mm 900 mm</p>	 <p>160 mm 240 mm 160 mm 1.2 mm Ø 32 mm 900 mm</p>
<p>2029 1.2 mm Ø 32 mm 900 mm</p>	<p>2029-A 1.2 mm Ø 32 mm 900 mm</p>	<p>2029-B 1.2 mm Ø 32 mm 900 mm</p>	<p>2032 1.2 mm Ø 32 mm 900 mm</p>	<p>2032-A 1.2 mm Ø 32 mm 900 mm</p>	<p>2032-B 1.2 mm Ø 32 mm 900 mm</p>

Konik Borular- Conical Pipes

Ø21 mm



Ø10 mm

2060
1 mm
Ø 21 mm
800 mm

Ø32 mm



Ø15 mm

2061
1.2 mm
Ø 32 mm
800 mm

□25x25 mm



Ø15 mm

2062
1.2 mm
25x25 mm
800 mm

Ø38 mm



Ø19 mm

2063
1.2 mm
Ø 38 mm
800 mm

□30x30 mm



Ø19 mm

2064
1.2 mm
30x30 mm
800 mm

Ø51 mm



Ø25 mm

2065
1.2 mm
Ø 51 mm
800 mm

□40x40 mm



Ø25 mm

2066
1.2 mm
40x40 mm
800 mm

Ø15 mm



Ø15 mm

2067
1.2 mm
Ø 32 mm
900 mm

Ø19 mm



Ø19 mm

2068
1.2 mm
Ø 38 mm
900 mm

Ø25 mm



Ø25 mm

2069
1.2 mm
Ø 51 mm
900 mm

Ø21 mm



Ø10 mm

2070
1 mm
Ø 21 mm
400 mm

Ø32 mm



Ø15 mm

2071
1.2 mm
Ø 32 mm
400 mm

Ø38 mm



Ø19 mm

2072
1 mm
Ø 38 mm
400 mm

Nervürlü Borular- Ribbed Pipes



2034
1.0 mm
Ø 28 mm
3000 mm



2035
1.0 mm
Ø 32 mm
3000 mm



2036
1.0 mm
Ø 38 mm
3000 mm



2037
1.2 mm
Ø 42 mm
3000 mm



2038
1.2 mm
Ø 48 mm
3000 mm



2039
1.2 mm
Ø 51 mm
3000 mm



2040
1.2 mm
Ø 60 mm
3000 mm



2041
1.5 mm
Ø 76 mm
3000 mm



2042
2.0 mm
Ø 89 mm
3000 mm



2043
2.0 mm
Ø 102 mm
3000 mm

****Nervürlü borular 6 metre uzunluğa kadar üretilebilir.**
****Ribbed pipes can be produced in lengths of up to 6 meters.**

Lazer Kesimli Dekoratif Profiller - Laser-Cut Decorative Profiles



3 yönlü-3 sides

2050

2 mm

□ 60mm 1200 mm



3 yönlü-3 sides

2051

2 mm

□ 80mm 1200 mm



3 yönlü-3 sides

2052

2 mm

□ 100mm 1200 mm



2 yönlü-2 sides

2053

2 mm

□ 60mm 1200 mm



2 yönlü-2 sides

2054

2 mm

□ 80mm 1200 mm



2 yönlü-2 sides

2055

2 mm

□ 100mm 1200 mm



3 yönlü-3 sides

2050-A

2 mm

□ 60mm 1200 mm



3 yönlü-3 sides

2051-A

2 mm

□ 80mm 1200 mm



3 yönlü-3 sides

2052-A

2 mm

□ 100mm 1200 mm



2 yönlü-2 sides

2053-A

2 mm

□ 60mm 1200 mm



2 yönlü-2 sides

2054-A

2 mm

□ 80mm 1200 mm



2 yönlü-2 sides

2055-A

2 mm

□ 100mm 1200 mm

Sıcak Dövme Küreler - Hot Forged Spheres



Kod Code	Ölçü Dimension	Ağırlık Weight	Kod Code	Ölçü Dimension	Ağırlık Weight
2500-A	Ø20 mm	0.04 kg	2505	Ø60 mm	1.04 kg
2500	Ø25 mm	0.08 kg	2506	Ø70 mm	1.40 kg
2501	Ø30 mm	0.14 kg	2507	Ø100 mm	4.11 kg
2503	Ø40 mm	0.30 kg	2508	Ø120 mm	7.11 kg
2504	Ø50 mm	0.60 kg			

Boş Sac Küreler - Hollow Spheres



Kod Code	Ölçü Dimension	Kalınlık Thickness	Kod Code	Ölçü Dimension	Kalınlık Thickness
3139	Ø30 mm	1 mm	3144	Ø80 mm	1 mm
3140	Ø40 mm	1 mm	3145	Ø90 mm	1 mm
3141	Ø50 mm	1 mm	3146	Ø100 mm	1 mm
3142	Ø60 mm	1 mm	3147	Ø120 mm	1 mm
3143	Ø70 mm	1 mm	3148	Ø150 mm	1 mm

Kabaralar - Rivets



Plastik Kapaklar - Plastic Lids



Kod Code	Ölçü Dimension	Kod Code	Ölçü Dimension
2720	15x15 mm	2726	60x60 mm
2721	20x20 mm	2727	70x70 mm
2722	25x25 mm	2728	80x80 mm
2723	30x30 mm	2729	100x100 mm
2724	40x40 mm	2730	120x120 mm
2725	50x50 mm		

Kod Code	Ölçü Dimension	Kod Code	Ölçü Dimension
2731	Ø25 mm	2736	Ø40 mm
2732	Ø30 mm	2737	Ø42 mm
2733	Ø32 mm	2738	Ø48 mm
2734	Ø35 mm	2739	Ø50 mm
2735	Ø38 mm		



Kod Code	Ölçü Dimension	Kod Code	Ölçü Dimension
2747	20x30 mm	2752	30x60 mm
2748	20x40 mm	2753	40x60 mm
2749	30x40 mm	2754	40x80 mm
2750	25x50 mm	2755	50x100 mm
2751	30x50 mm		

Boru & Profil Kapakları - Pipe & Profile Lids

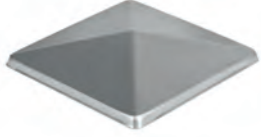

Kod Code	İç Ölçü □ Hole	Kalınlık Thickness
3000	30x30 mm	0.7 mm
3001	40x40 mm	0.7 mm
3002	50x50 mm	0.7 mm
3003	60x60 mm	0.7 mm
3004	80x80 mm	0.7 mm
3005	100x100 mm	0.7 mm

Kod Code	İç Ölçü □ Hole	Kalınlık Thickness
3006-A	120x120 mm	0.7 mm
3007-A	150x150 mm	0.7 mm
3008-A	175x175 mm	0.7 mm
3009-A	200x200 mm	0.7 mm

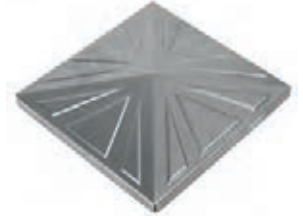

Kod Code	İç Ölçü ⊘ Hole	Kalınlık Thickness
3010	50x100 mm	0.7 mm
3011	40x80 mm	0.7 mm
3012	40x60 mm	0.7 mm
3013	30x60 mm	0.7 mm
3014	30x50 mm	0.7 mm
3015	30x40 mm	0.7 mm
3016	20x40 mm	0.7 mm
3017	20x30 mm	0.7 mm

Kod Code	İç Ölçü ⊘ Hole	Kalınlık Thickness
3020	Ø30 mm	0.7 mm
3021	Ø33 mm	0.7 mm
3022	Ø42 mm	0.7 mm
3023	Ø48 mm	0.7 mm
3024	Ø51 mm	0.7 mm
3025	Ø60 mm	0.7 mm
3026	Ø76 mm	0.7 mm
3027	Ø89 mm	0.7 mm
3028	Ø101 mm	0.7 mm
3029	Ø114 mm	0.7 mm



Kod Code	İç Ölçü ⊘ Hole	Kalınlık Thickness
3030	Ø19 mm	1.2 mm
3031	Ø32 mm	1.2 mm
3032	Ø38 mm	1.2 mm
3033	Ø42 mm	1.2 mm
3034	Ø48 mm	1.2 mm
3035	Ø51 mm	1.2 mm
3036	Ø60 mm	1.2 mm
3036-A	Ø76 mm	1.2 mm
3037	Ø101 mm	1.2 mm

Kod Code	İç Ölçü ⊘ Hole	Kalınlık Thickness
3039	Ø30 mm	0.9 mm
3040	Ø40 mm	0.9 mm
3041	Ø50 mm	0.9 mm
3042	Ø60 mm	0.9 mm
3043	Ø70 mm	0.9 mm
3044	Ø80 mm	0.9 mm
3045	Ø90 mm	0.9 mm
3046	Ø100 mm	0.9 mm
3047	Ø120 mm	0.9 mm
3048	Ø150 mm	1.0 mm



Kod Code	Taban Ölçüsü ⊘ Lid Dimension
3050	Ø30 mm
3051	Ø33 mm
3052	Ø42 mm
3053	Ø48 mm
3054	Ø51 mm
3055	Ø60 mm
3056	Ø76 mm
3057	Ø90 mm
3058	Ø101 mm
3059	Ø114 mm

Kod Code	Taban Ölçüsü □ Lid Dimension
3063	30x30 mm
3064	40x40 mm
3065	50x50 mm
3066	60x60 mm
3067	80x80 mm
3068	100x100 mm





Kod Code	Taban Ölçüsü Lid Dimension	Kalınlık Thickness
3060	51x75 mm (30'lık)	1 mm
3061	58x96 mm (40'lık)	1 mm
3062	68x102 mm (50'lik)	1 mm

Kod Code	Taban Ölçüsü Lid Dimension	Yükseklik Height	Kalınlık Thickness
3076	60x60 mm	100 mm	1.5 mm
3077	80x80 mm	125 mm	1.5 mm
3073	100x100 mm	130 mm	1.5 mm
3074	120x120 mm	140 mm	1.5 mm
3075	150x150 mm	160 mm	1.5 mm
3078	175x175 mm	165 mm	1.5 mm



Boru & Profil Flanşları - Pipe & Profile Flanges

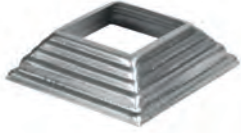

Kod Code	İç Ölçü Hole	Dış Ölçü Width	Yükseklik Height
3100	12x12 mm	50x50 mm	20 mm
3101	14x14 mm	50x50 mm	20 mm
3102	16x16 mm	50x50 mm	20 mm
3106-A	20x20 mm	50x50 mm	20 mm
3106	20x20 mm	70x70 mm	25 mm
3107	25x25 mm	70x70 mm	25 mm
3108	30x30 mm	70x70 mm	25 mm
3108-A	30x30 mm	90x90 mm	28 mm
3109	40x40 mm	90x90 mm	28 mm
3109-A	40x40 mm	100x100 mm	28 mm
3110	50x50 mm	100x100 mm	28 mm
3111	60x60 mm	100x100 mm	28 mm
3112	80x80 mm	120x120 mm	28 mm
3113	100x100 mm	140x140 mm	28 mm

Kod Code	İç Ölçü Hole	Dış Ölçü Width	Yükseklik Height
3120	Ø12 mm	Ø50 mm	16 mm
3121	Ø14 mm	Ø50 mm	16 mm
3122	Ø16 mm	Ø50 mm	16 mm
3122-A	Ø20 mm	Ø50 mm	16 mm
3123	Ø25 mm	Ø80 mm	25 mm
3124	Ø28 mm	Ø80 mm	25 mm
3125	Ø32 mm	Ø80 mm	25 mm
3126	Ø38 mm	Ø97 mm	30 mm
3127	Ø42 mm	Ø97 mm	30 mm
3128	Ø48 mm	Ø97 mm	30 mm
3129	Ø51 mm	Ø110 mm	30 mm
3130	Ø60 mm	Ø110 mm	30 mm

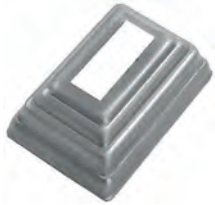

Kod Code	İç Ölçü Hole	Dış Ölçü Width	Yükseklik Height
3116	20x10 mm	45x65 mm	24 mm
3104	20x30 mm	70x70 mm	25 mm
3103	20x40 mm	90x90 mm	28 mm
3117	30x10 mm	45x65 mm	24 mm
3115	30x40 mm	90x90 mm	28 mm
3105	30x50 mm	100x100 mm	28 mm
3118	40x10 mm	45x85 mm	24 mm
3114	40x60 mm	100x100 mm	28 mm
3119	50x10 mm	45x85 mm	24 mm

Kod Code	İç Ölçü Hole	Dış Ölçü Width	Yükseklik Height
3133	26x51 mm	Ø76 mm	16 mm

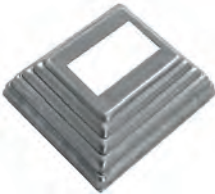

Kod Code	İç Ölçü Hole	Dış Ölçü Width	Yükseklik Height
3134	56x54 mm	Ø90 mm	16 mm

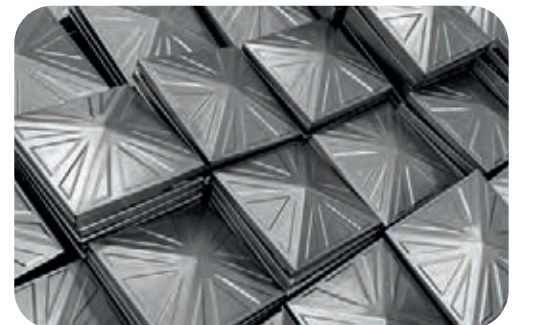
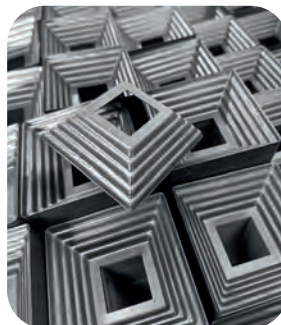

Dövme Rozetler - Forged Rosettes



3750

80x80 mm
4 mm



3751

80x80 mm
□21x21 mm
4 mm



3753

80x80 mm
□31x31 mm
4 mm



3750-A

77x77 mm
2 mm



3751-A

77x77 mm
□21x21 mm
2 mm



3753-A

77x77 mm
□31x31 mm
2 mm



3754

60x60 mm
4 mm



3755

60x60 mm
□13x13 mm
4 mm



3756

60x60 mm
□17x17 mm
4 mm



3757

60x60 mm
6 mm



3758

60x60 mm
□13x13 mm
6 mm

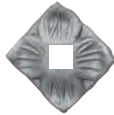

3759

60x60 mm
□17x17 mm
6 mm



3760

80x80 mm
4 mm



3761

80x80 mm
□21x21 mm
4 mm



3762

80x80 mm
□26x26 mm
4 mm



3766

110x110 mm
8 mm



3767

110x110 mm
□31x31 mm
8 mm



3768

110x110 mm
□41x41 mm
8 mm



3766-A

110x110 mm
4 mm



3767-A

110x110 mm
□31x31 mm
4 mm



3768-A

110x110 mm
□41x41 mm
4 mm



3773

65x65 mm
4 mm



3774

65x65 mm
□13x13 mm
4 mm



3775

65x65 mm
□17x17 mm
4 mm



3773-A

76x76 mm
2 mm



3774-A

76x76 mm
□13x13 mm
2 mm



3775-A

76x76 mm
□17x17 mm
2 mm



3776

Ø 65 mm
3 mm



3777

Ø 65 mm
□13x13 mm
3 mm



3778

Ø 65 mm
□17x17 mm
3 mm

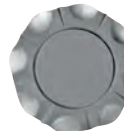

3779

Ø 90 mm
3 mm



3780

Ø 90 mm
□21x21 mm
3 mm



3781

Ø 90 mm
□26x26 mm
3 mm



3782

110x110 mm
4 mm



3783

110x110 mm
□21x21 mm
4 mm



3784

110x110 mm
□26x26 mm
4 mm



3782-A

105x105 mm
2 mm



3783-A

105x105 mm
□21x21 mm
2 mm



3784-A

105x105 mm
□26x26 mm
2 mm

Lazer Kesim Flanşlar - Laser-Cut Flanges

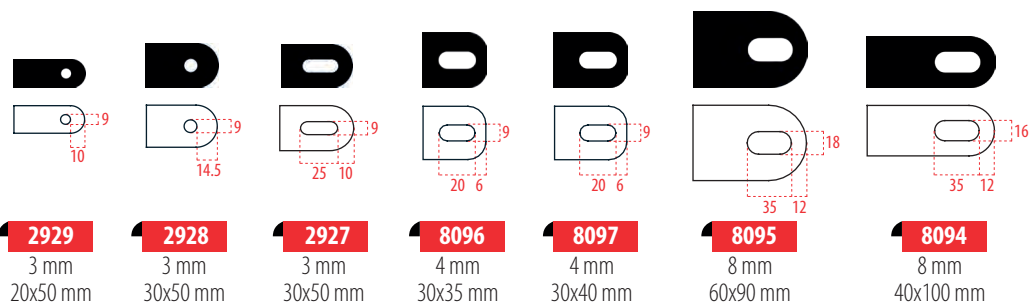
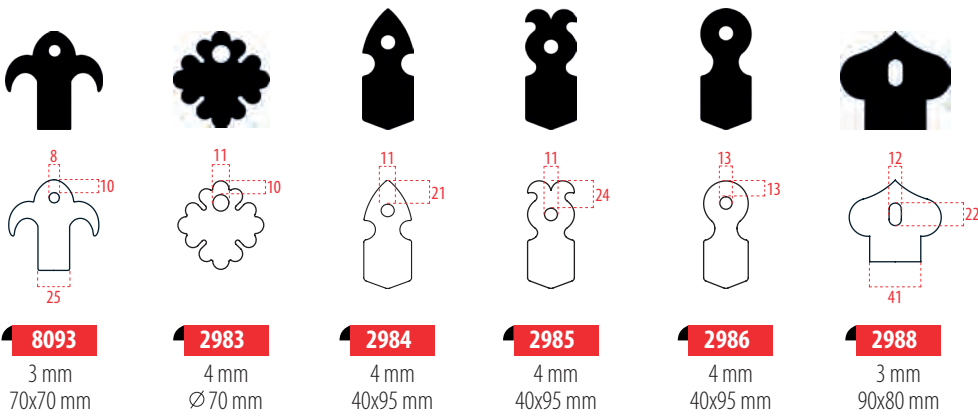
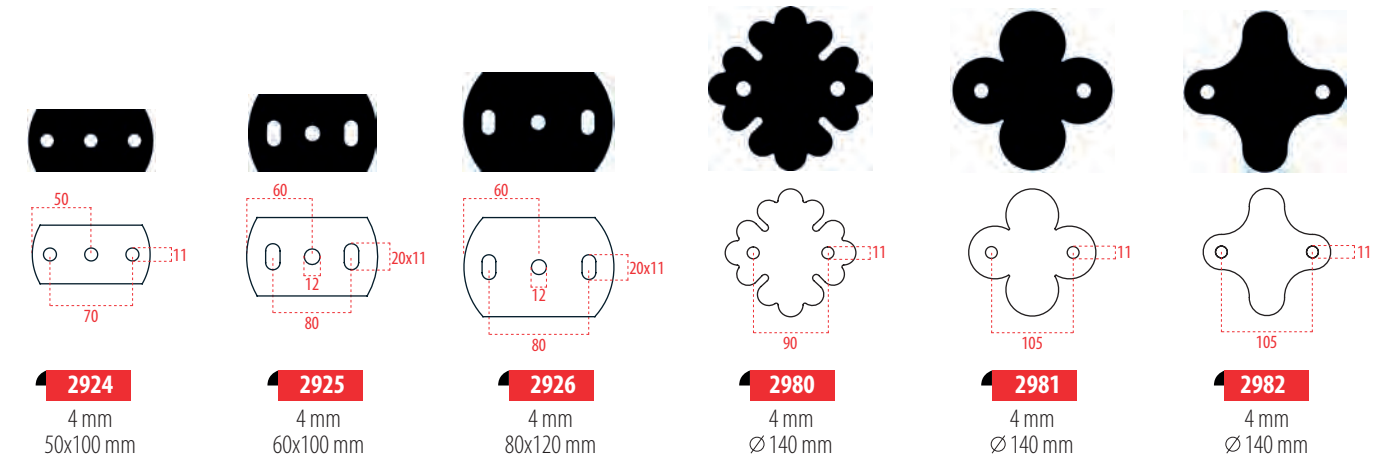
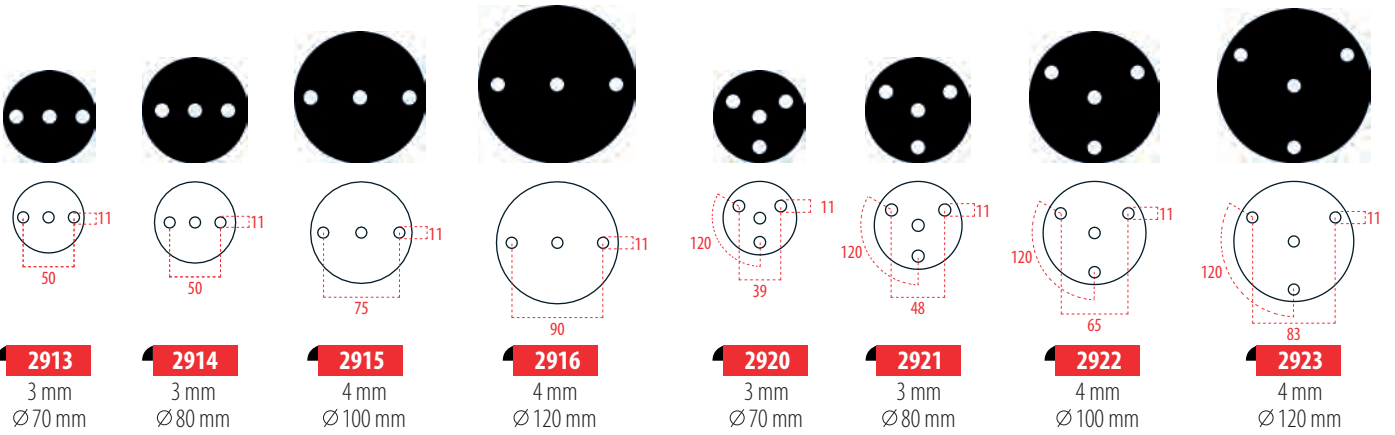

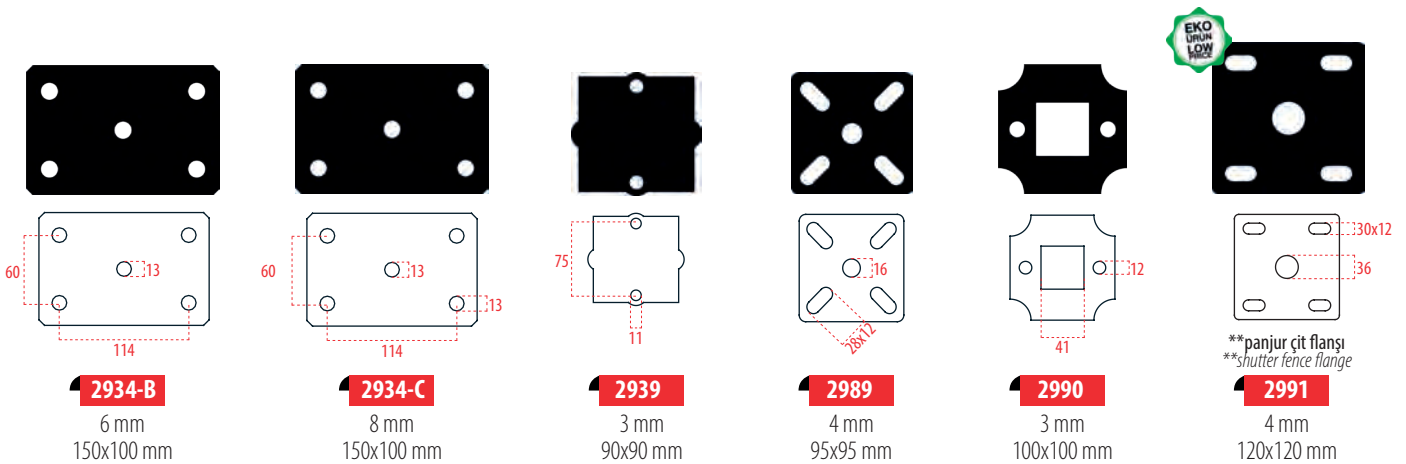
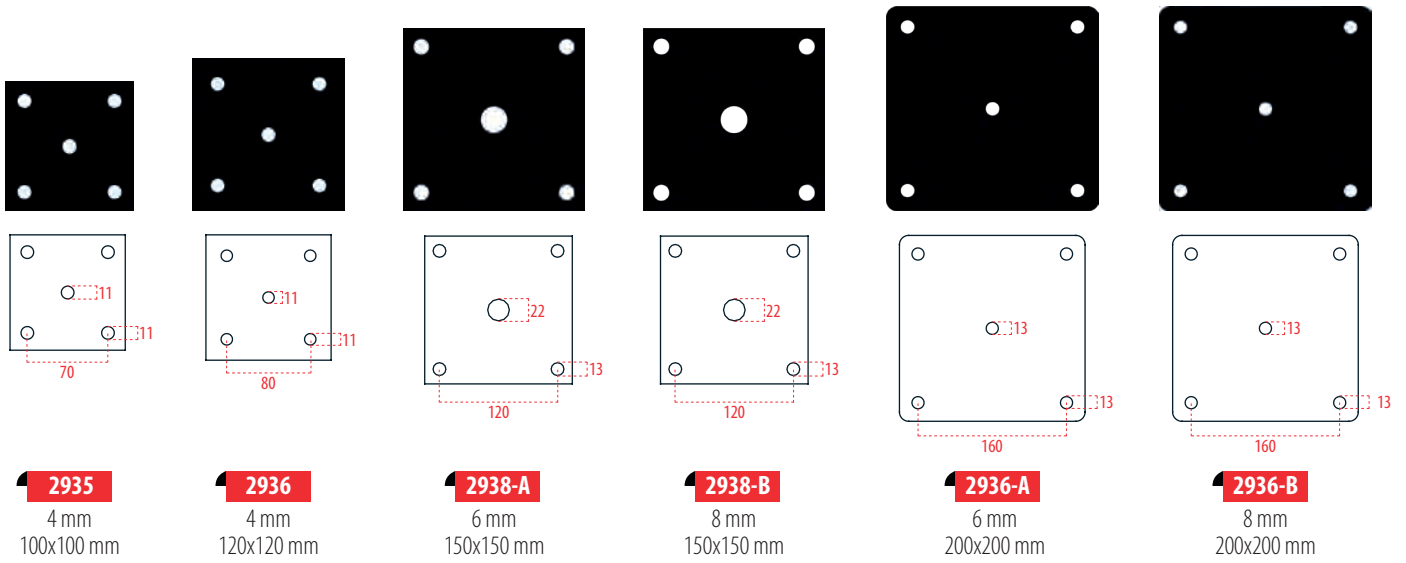
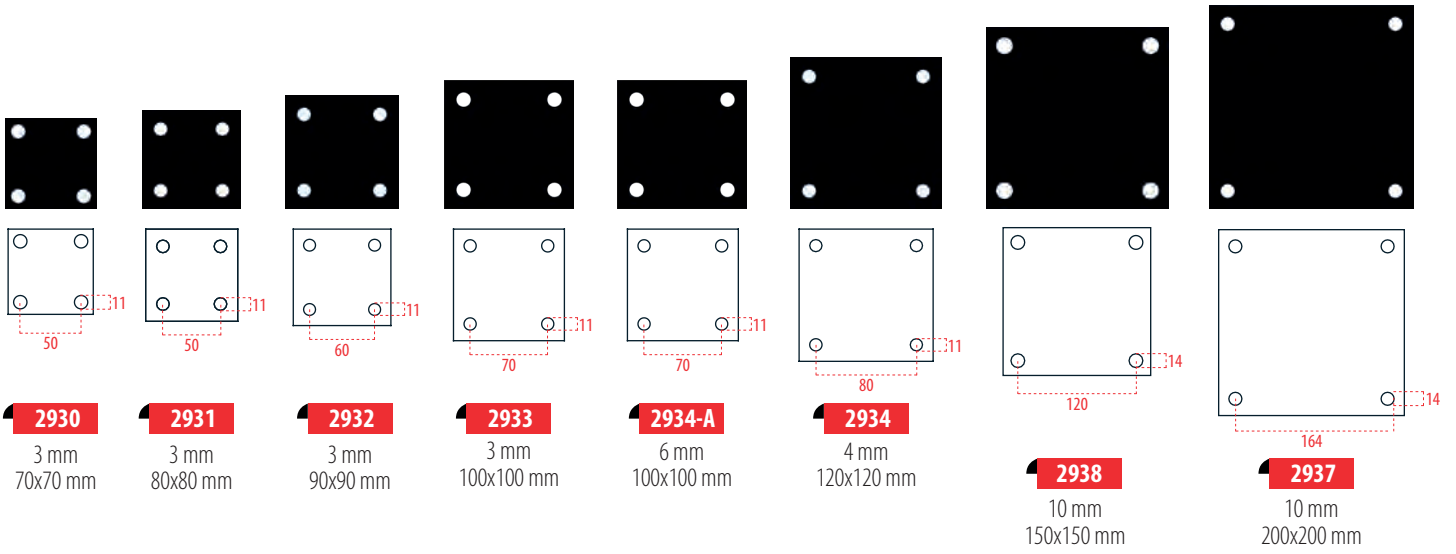

Sac Rozetler - Sheet Rosettes

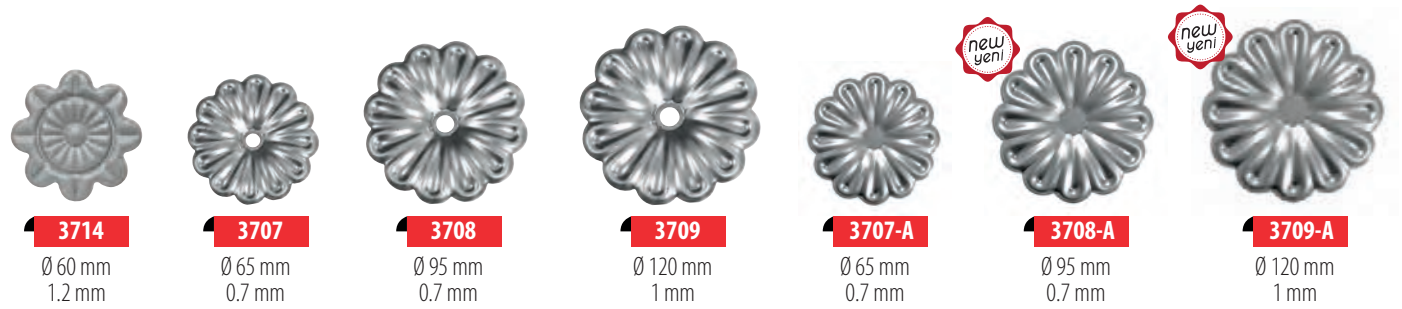
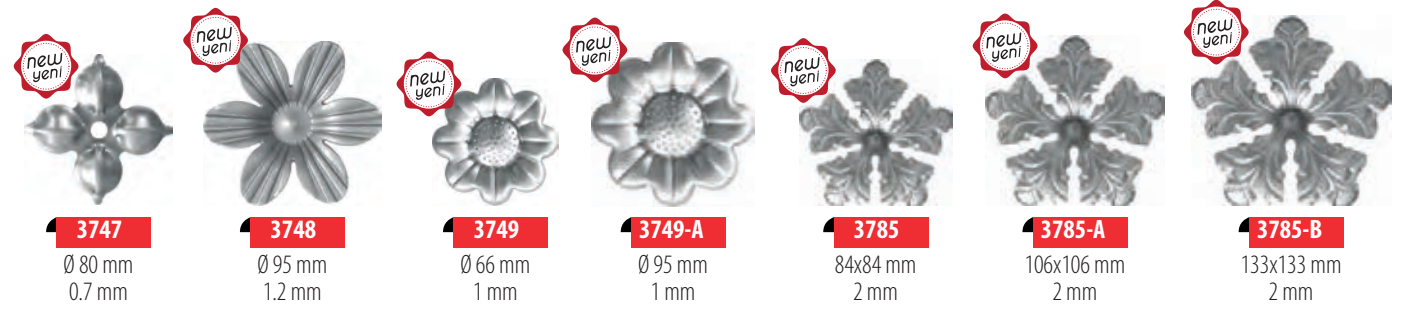
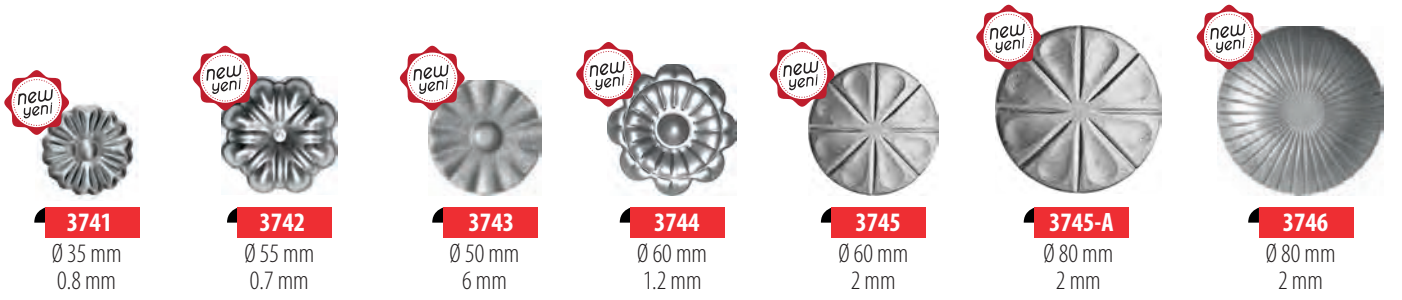
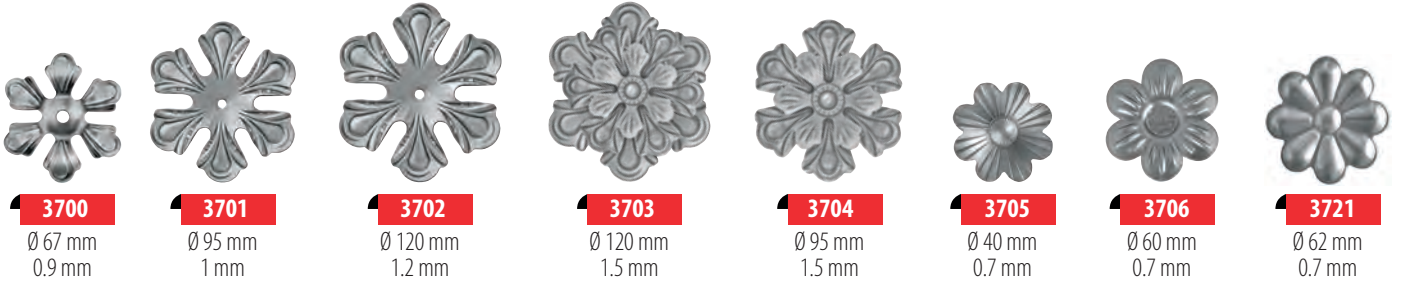

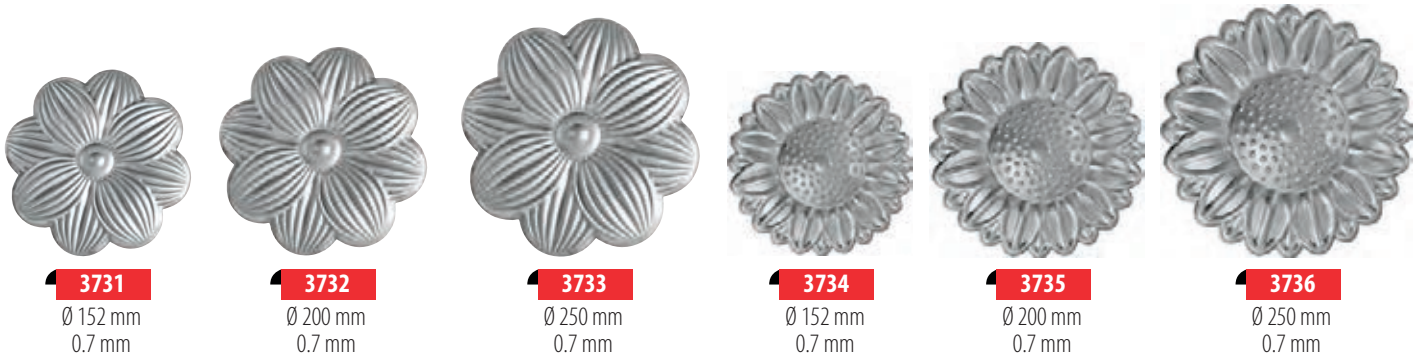
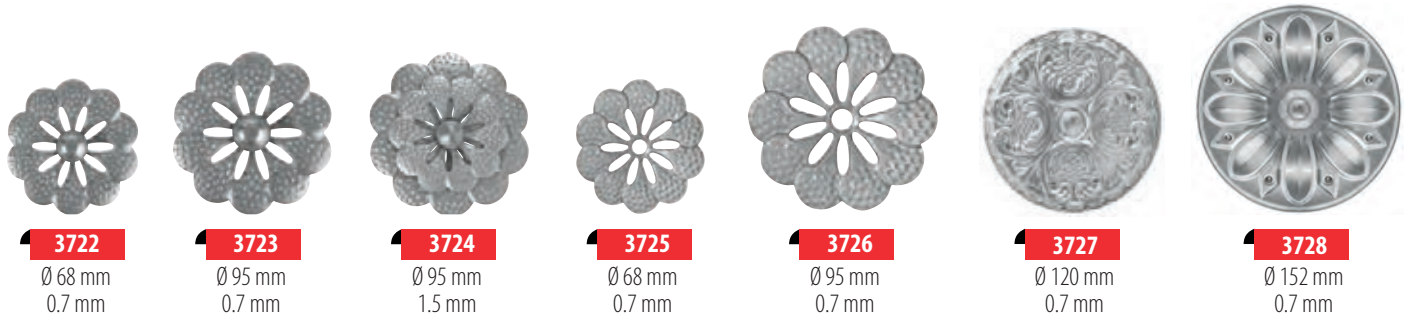
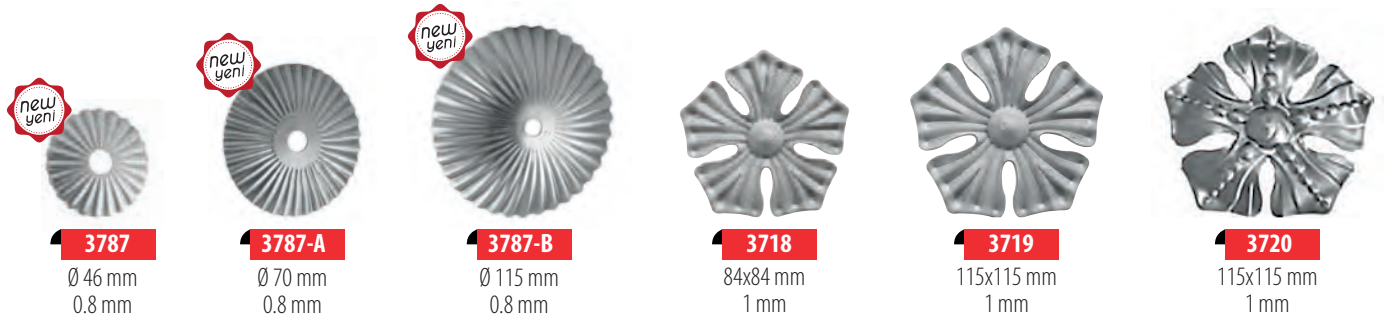

Sac Yapraklar- Sheet Leaves

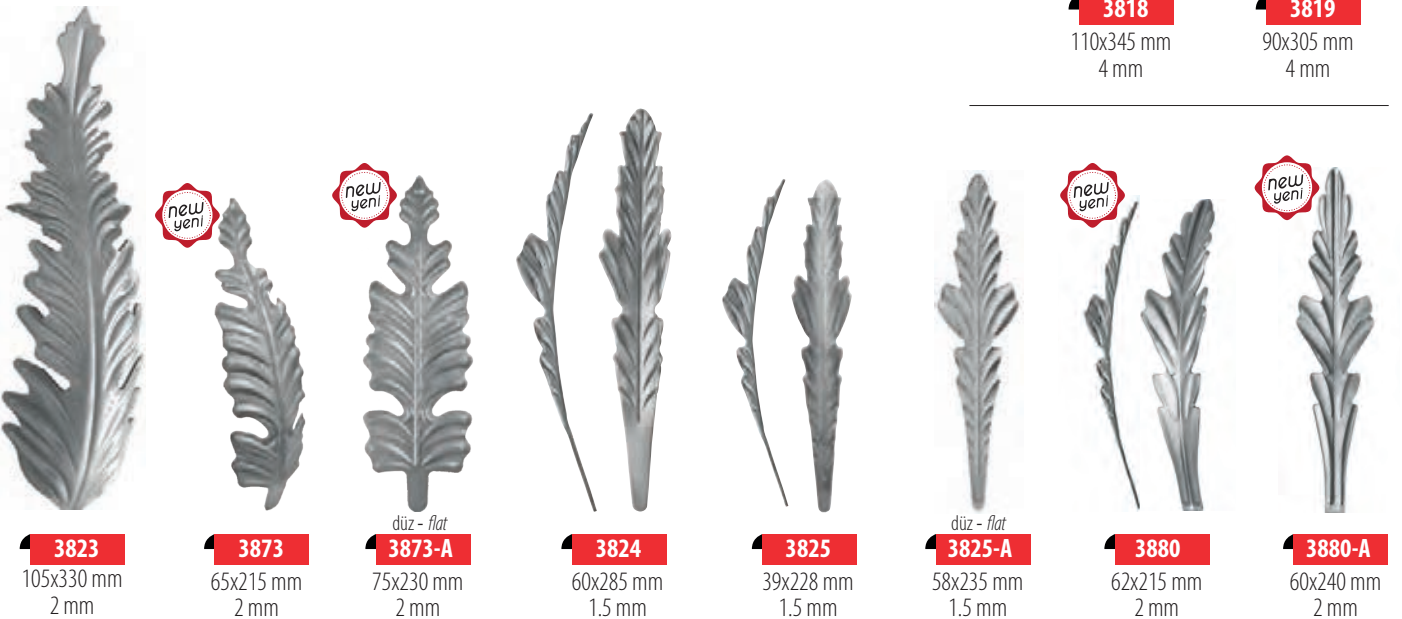
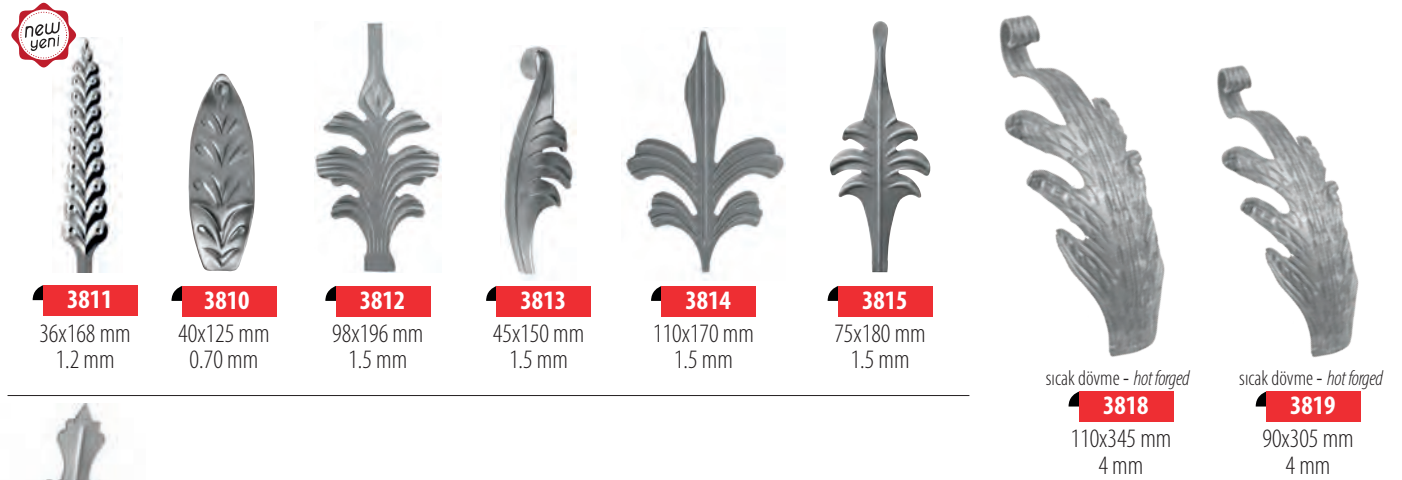
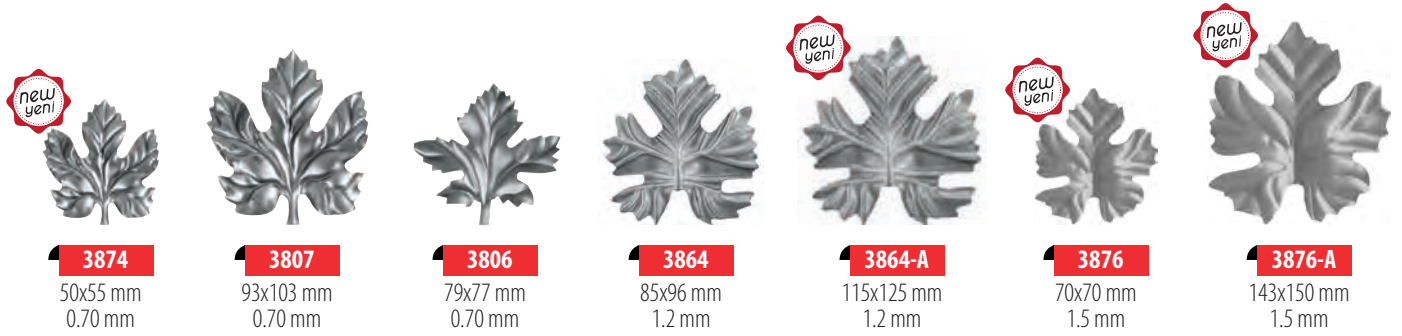
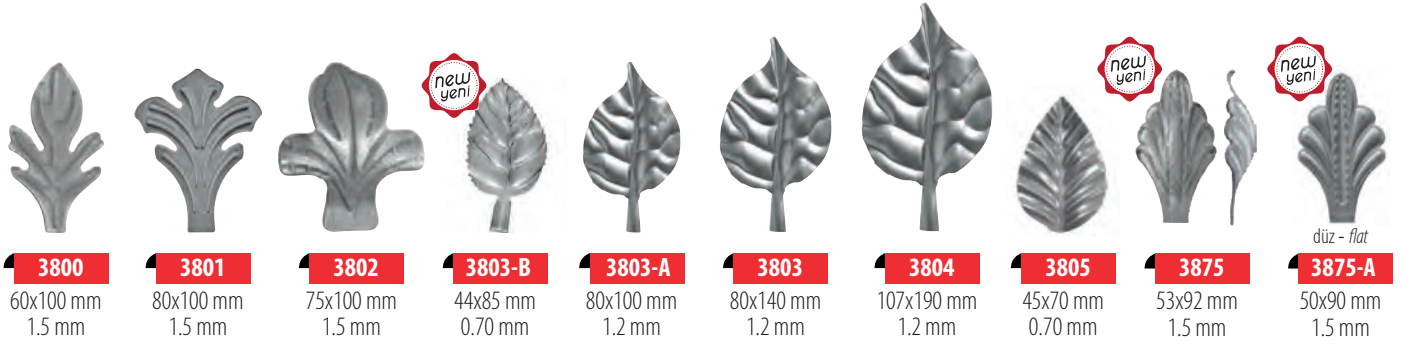

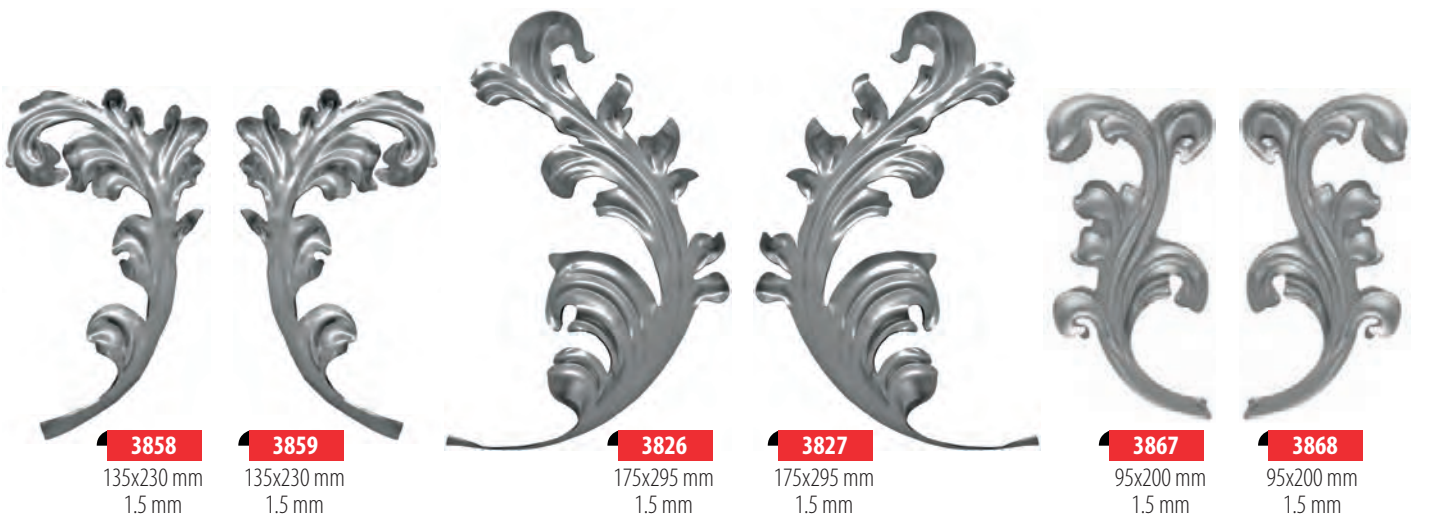
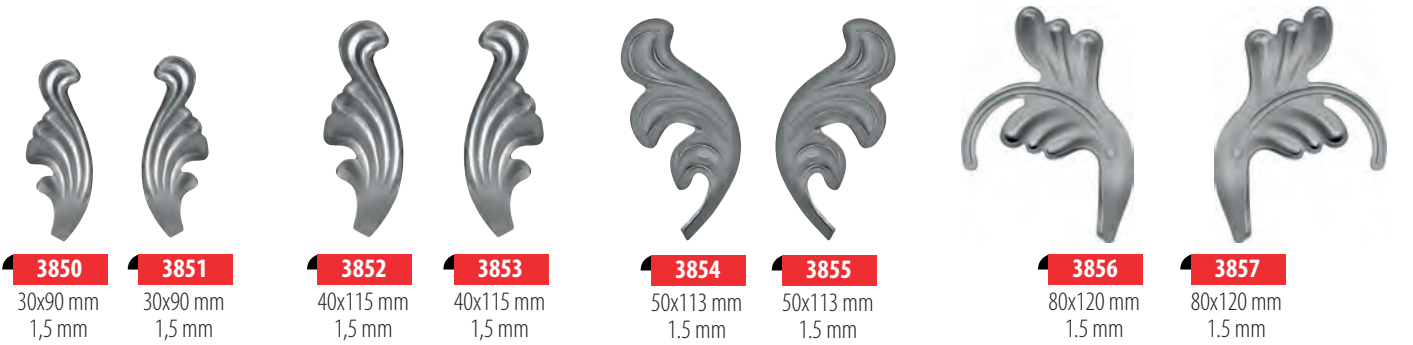
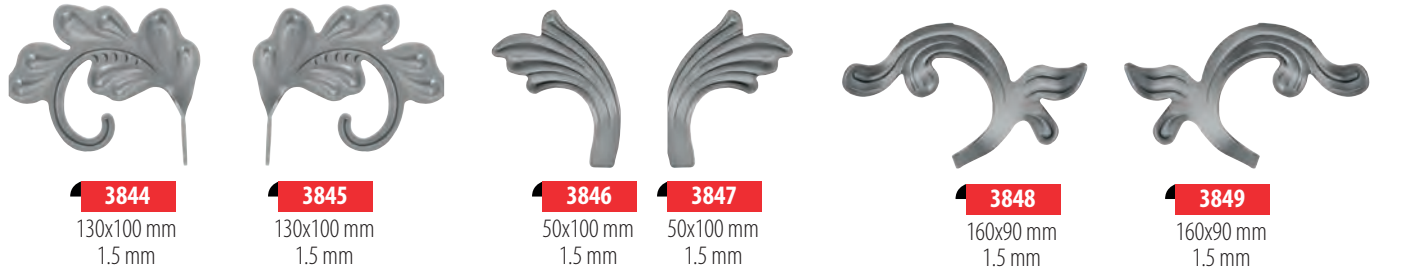
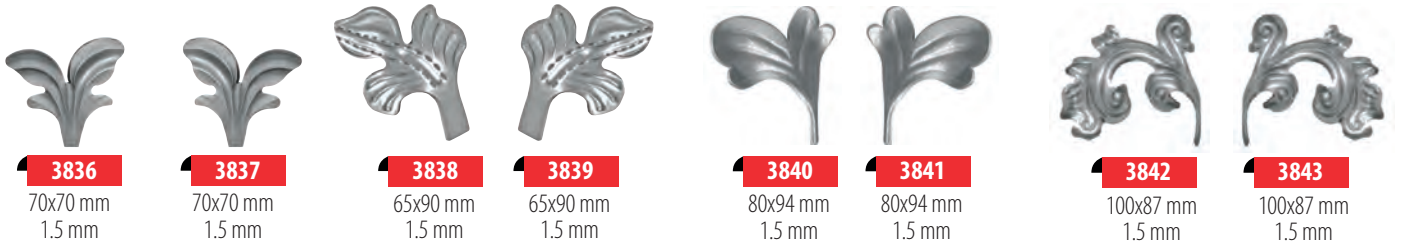
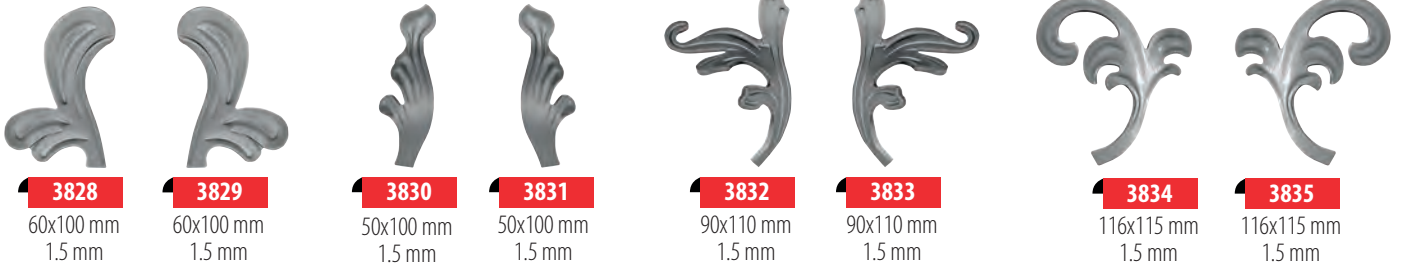

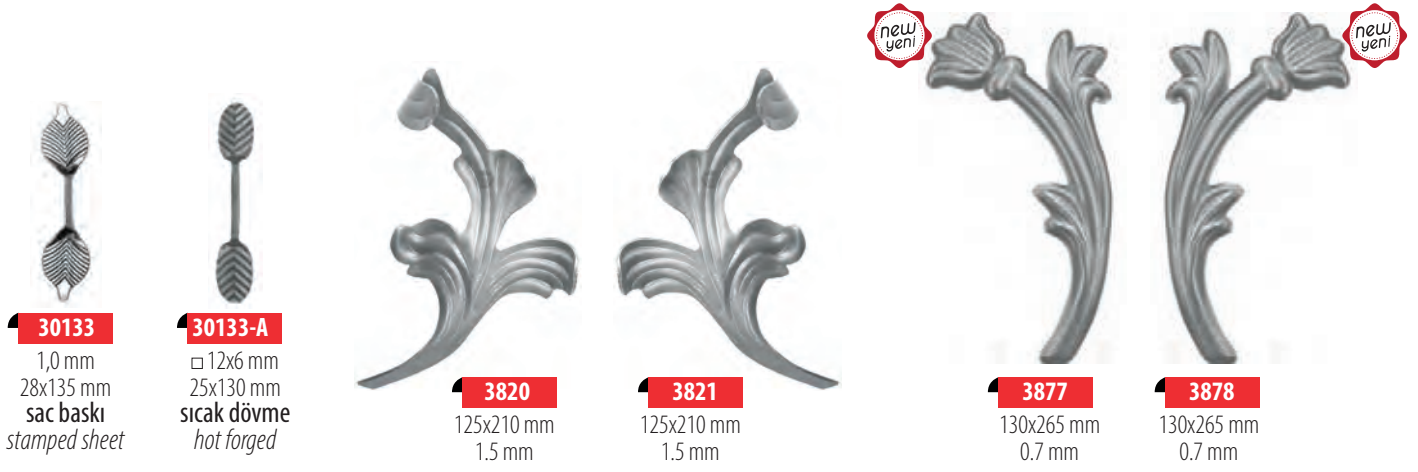
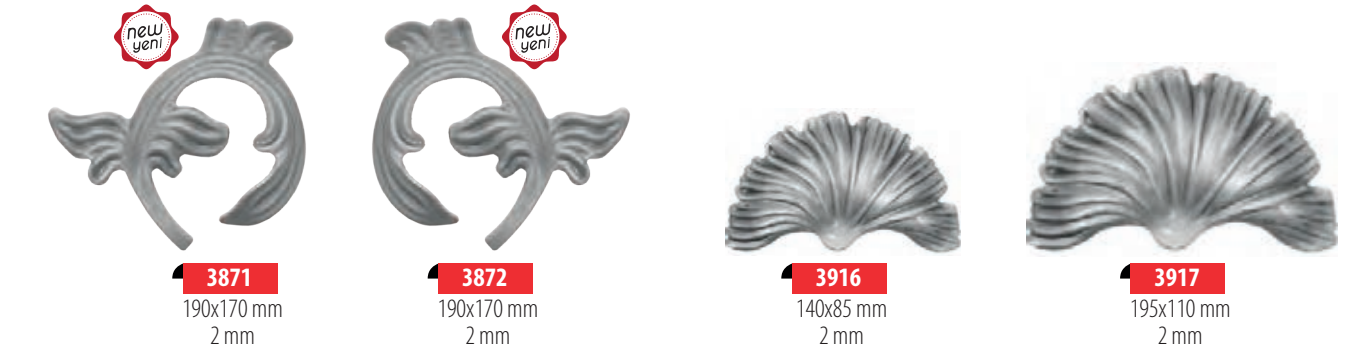

Sac Motifler - Sheet Motifs



3900
290x90 mm
0.70 mm



3901
340x175 mm
0.70 mm



3903
360x140 mm
0.70 mm



3907
285x200 mm
0.70 mm



3902
405x227 mm
0.70 mm



3902-A
330x180 mm
0.70 mm



3904
380x170 mm
0.70 mm



3992
355x170 mm
0.70 mm



3994
440x275 mm
0.70 mm



3906-A
465x270 mm
0.70 mm



3906
350x210 mm
0.70 mm



3990-B
470x270 mm
0.70 mm



3990-A
405x210 mm
0.70 mm



3990
360x195 mm
0.70 mm



3911
345x170 mm
0.70 mm



3918
365x180 mm
0.70 mm



3667
220x160 mm
0.80 mm



3666
108x66 mm
0.70 mm



3910
350x235 mm
0.70 mm



3993
260x235 mm
0.70 mm



3905
380x220 mm
0.70 mm



3914
235x350 mm
0.70 mm



3661
430x235 mm
0.70 mm



3662
400x280 mm
0.70 mm



3913
125x246 mm
1.5 mm



3949
275x378 mm
0.70 mm



3660
130x290 mm
0.70 mm



3912
240x383 mm
0.70 mm



3921-A
342x414 mm
0.70 mm



3947-A
290x510 mm
0.70 mm



3947
254x446 mm
0.70 mm

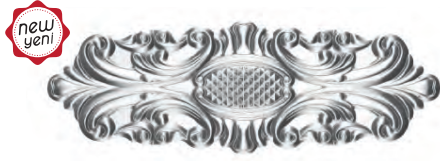

3665
368x135 mm
0.80 mm



3998
375x100 mm
0.70 mm



3995
465x95 mm
0.70 mm



3991
375x100 mm
0.70 mm



3920
470x290 mm
0.70 mm



3920-A
375x240 mm
0.70 mm



3923
393x168 mm
0.70 mm



3922
565x282 mm
0.70 mm



3668
734x184 mm
0.80 mm



3996
660x200 mm
0.70 mm



3997
660x200 mm
0.70 mm



3996-A
475x144 mm
0.70 mm



3997-A
475x144 mm
0.70 mm



3919
285x570 mm
0.70 mm



3919-A
150x350 mm
0.70 mm



3948
455x500 mm
0.70 mm



3946
295x580 mm
0.70 mm



3915-A
465x285 mm
0.70 mm

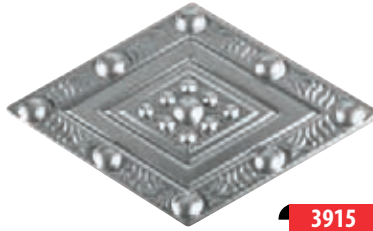

3915
345x205 mm
0.70 mm



3908
115x189 mm
0.70 mm



3909
100x215 mm
0.70 mm



3664
665x285 mm
0.70 mm

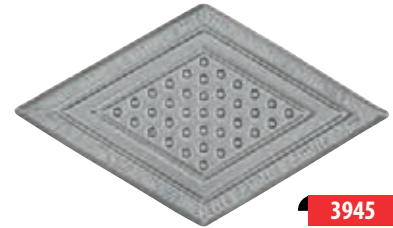

3945
345x205 mm
0.70 mm



3927-A
400x200 mm
0.70 mm



3927
200x200 mm
0.70 mm



3938
485x240 mm
0.70 mm



3937
240x240 mm
0.70 mm

new
yeni



3663

52x95 mm
0.70 mm



3924

82x82 mm
0.70 mm



3925

85x85 mm
0.70 mm



3926

105x105 mm
0.70 mm



3928

210x210 mm
0.70 mm



3929

105x105 mm
0.70 mm



3930

155x155 mm
0.70 mm



3931

200x200 mm
0.70 mm



3932

250x250 mm
0.70 mm



kod/code : 3606

kod/code : 3919

Sac Köşeler - Sheet Corners



3933

125x125 mm
0.70 mm



3934

135x135 mm
0.70 mm



3935

164x164 mm
0.70 mm



3942

115x115 mm
0.70 mm



3943

130x130 mm
0.70 mm

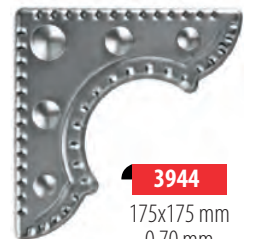

3944

175x175 mm
0.70 mm



3936-A

150x150 mm
0.70 mm

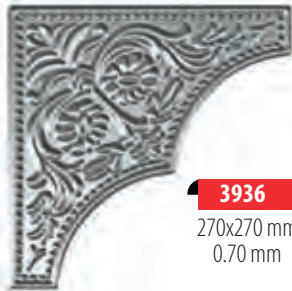

3936

270x270 mm
0.70 mm



3939

145x145 mm
0.70 mm



3940

145x145 mm
0.70 mm

new
yeni



3941-A

150x150 mm
0.70 mm



3941

165x165 mm
0.70 mm

new
yeni



3694

88x88 mm
0.80 mm

new
yeni



3695

95x95 mm
0.70 mm

new
yeni



3696

146x146 mm
0.70 mm

new
yeni



3697

100x100 mm
0.70 mm

new
yeni



3698

130x130 mm
0.70 mm

new
yeni



3699

195x195 mm
0.70 mm

Sac Ara Parçalar - Sheet Connection Pieces

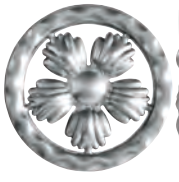

3670

Ø 120 mm
0.70 mm

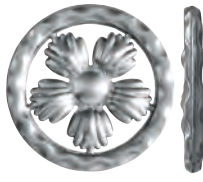

3671

Ø 120 mm
0.70 mm



3672

Ø 120 mm
0.70 mm



3673

Ø 120 mm
0.70 mm



3674

Ø 125 mm
0.70 mm



3675

Ø 125 mm
0.70 mm



3676

□ 12x12 mm
60x145 mm
0.70 mm



3677

□ 14x14 mm
60x145 mm
0.70 mm



3678

□ 16x16 mm
60x145 mm
0.70 mm



3679

□ 12x12 mm
40x126 mm
0.70 mm



3680

□ 14x14 mm
40x126 mm
0.70 mm



3681

□ 16x16 mm
40x126 mm
0.70 mm



3682

Ø 12 mm
40x126 mm
0.70 mm



3683

Ø 14 mm
40x126 mm
0.70 mm



3684

Ø 16 mm
40x126 mm
0.70 mm



3685

□ 12x12 mm
60x145 mm
0.70 mm



3686

□ 14x14 mm
60x145 mm
0.70 mm



3687

□ 16x16 mm
60x145 mm
0.70 mm



3688

□ 12x12 mm
40x126 mm
0.70 mm



3689

□ 14x14 mm
40x126 mm
0.70 mm



3690

□ 16x16 mm
40x126 mm
0.70 mm



3691

Ø 12 mm
40x126 mm
0.70 mm



3692

Ø 14 mm
40x126 mm
0.70 mm



3693

Ø 16 mm
40x126 mm
0.70 mm



3974

□ 14 mm
49x49 mm
1 mm



3975

□ 16 mm
49x49 mm
1 mm



3976

Ø 14 mm
49x49 mm
1 mm



3977

Ø 16 mm
49x49 mm
1 mm



kod/code: 3937

Sac Göbekler - Sheet Centers



3501
0.70 mm
595x725 mm
tek (single)



3502
0.70 mm
595x900 mm
çift-kaynaklı
(double-welded)



3503
0.70 mm
470x670 mm
tek (single)

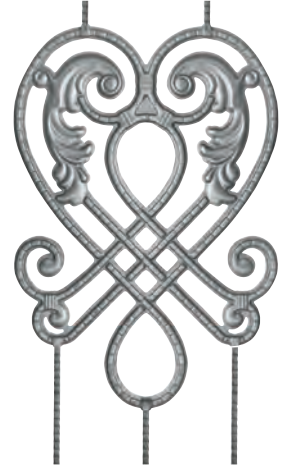

3504
0.70 mm
470x900 mm
çift-kaynaklı
(double-welded)



3505
0.70 mm
490x630 mm
tek (single)

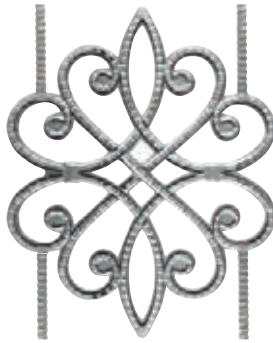

3506
0.70 mm
490x900 mm
çift-kaynaklı
(double-welded)



3507
0.70 mm
620x620 mm
tek (single)



3508
0.70 mm
620x900 mm
çift-kaynaklı
(double-welded)



3553
0.70 mm
330x780 mm
tek (single)



3554
0.70 mm
330x900 mm
çift-kaynaklı
(double-welded)



kod/code : 3503

kod/code : 3572



3559
0.70 mm
275x755 mm
tek (single)



3560
0.70 mm
275x755 mm
çift-kaynaklı
(double-welded)



3561
0.70 mm
275x900 mm
çift-kaynaklı
(double-welded)



3566
0.70 mm
300x765 mm
tek (single)



3567
0.70 mm
300x765 mm
çift-kaynaklı
(double-welded)



3568
0.70 mm
365x795 mm
tek (single)



3569
0.70 mm
365x900 mm
çift-kaynaklı
(double-welded)



3570
0.70 mm
230x755 mm
tek (single)



3571
0.70 mm
230x900 mm
çift-kaynaklı
(double-welded)



3572
0.70 mm
67x850 mm
tek (single)



3573
0.70 mm
67x1000 mm
çift-kaynaklı
(double-welded)

Sac Bordürler - Sheet Frames

3600

80x1000 mm
0.70 mm



3601

84x1000 mm
0.70 mm



3602

42x1000 mm
0.70 mm



3603

63x1000 mm
0.70 mm



3604

84x1000 mm
0.70 mm



3605

100x1000 mm
0.70 mm



3606

100x1000 mm
0.70 mm

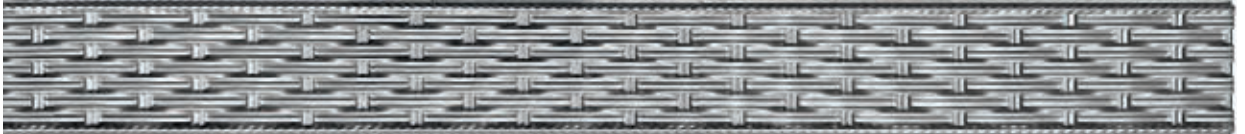

3608

100x1000 mm
0.70 mm



3610

107x1000 mm
0.70 mm

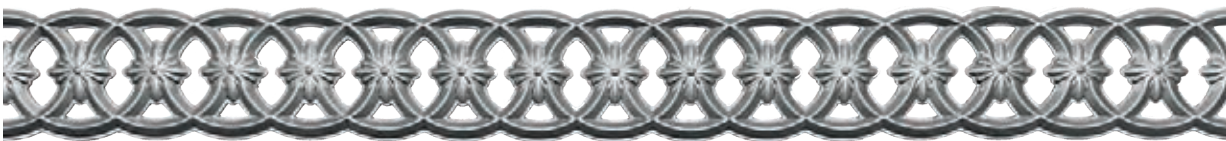

****Sac bordürler 1000mm-2000mm-3000mm uzunluk alternatiflerinde üretilebilir.**
****Sheet frames can be produced as 1000mm-2000mm-3000mm length.**

**3611**84x1000 mm
0.70 mm**3612**69x1000 mm
0.70 mm**3613**69x1000 mm
0.70 mm**3614**68x1000 mm
0.70 mm**3615**93x1000 mm
0.70 mm**3616**68x1000 mm
0.70 mm**3617**100x1000 mm
0.70 mm**3618**85x1000 mm
0.70 mm**3619**42x1000 mm
0.70 mm**3620**90x1000 mm
0.70 mm

****Sac bordürler 1000mm-2000mm-3000mm uzunluk alternatiflerinde üretilebilir.**

****Sheet frames can be produced as 1000mm-2000mm-3000mm length.**

3622
80x1000 mm
0.70 mm



3623
100x1000 mm
0.70 mm

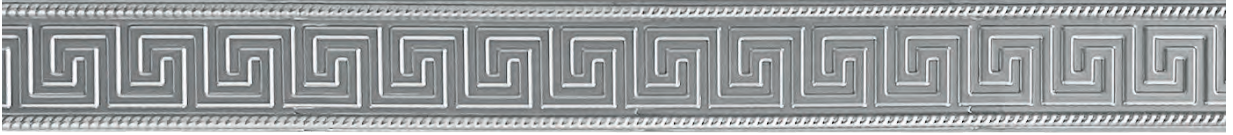

3650
100x944 mm
3 mm



3650-A
100x944 mm
2 mm

3651
120x991 mm
3 mm



3651-A
120x991 mm
2 mm

3652
120x944 mm
3 mm



3652-A
120x944 mm
2 mm

3653
100x1000 mm
3 mm



3653-A
100x1000 mm
2 mm

3654
120x1000 mm
3 mm



3654-A
120x1000 mm
2 mm

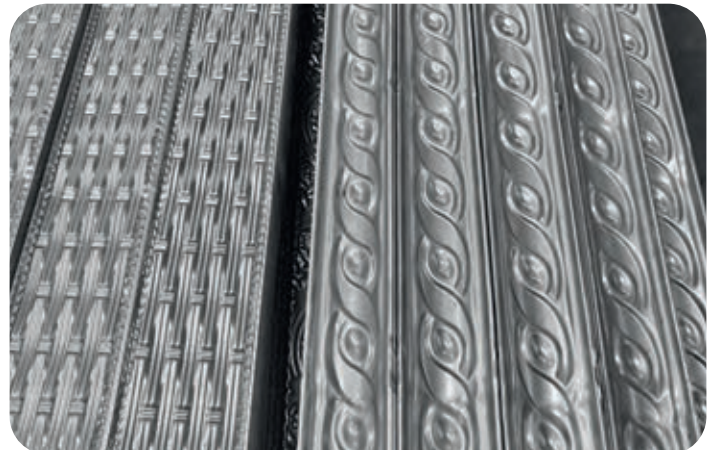
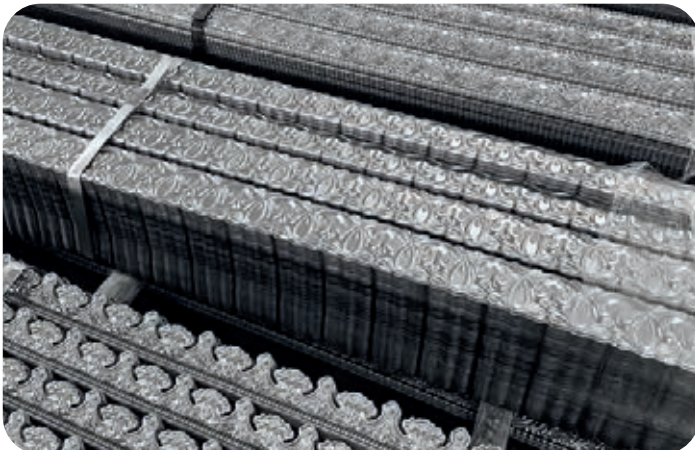

**Sac bordürler 1000mm-2000mm-3000mm uzunluk alternatiflerinde üretilebilir.

**Sheet frames can be produced as 1000mm-2000mm-3000mm length.

Keleþçeler - Collar Bars

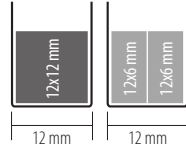
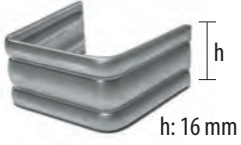

2850
12x12 mm
1,2 mm

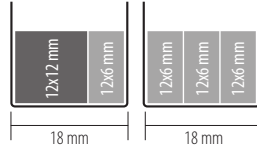

2851
12x18 mm
1,2 mm

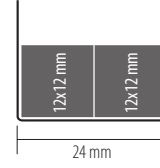

2852
12x24 mm
1,2 mm

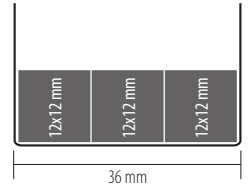

2853
12x36 mm
1,2 mm

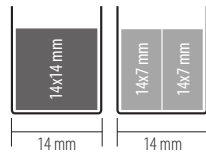

2854
14x14 mm
1,2 mm

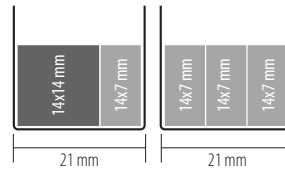

2855
14x21 mm
1,2 mm

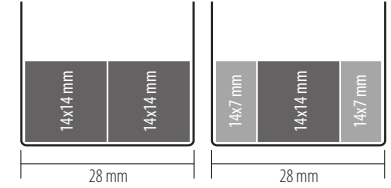

2856
14x28 mm
1,2 mm



2967
keleþçe sacı
/ collar sheet
16x2000 mm
1,2 mm

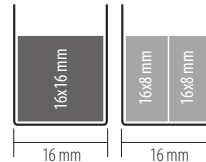

2857
16x16 mm
1,2 mm

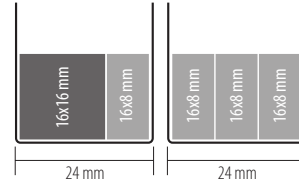

2858
16x24 mm
1,2 mm

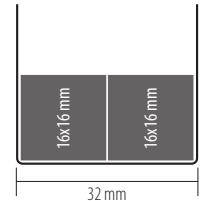

2859
16x32 mm
1,2 mm

Patina Boyalar ve Tinerler - Paints and Paint Thinners

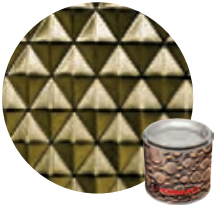

4000
patina altın / patina gold
0.25 - 1.00 kg.



4001
patina bakır / patina copper
0.25 - 1.00 kg.



4002
patina bronz / patina bronze
0.25 - 1.00 kg.

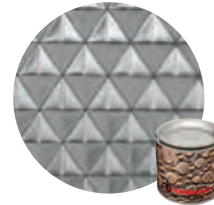

4003
patina gümüş / patina silver
0.25 - 1.00 kg.

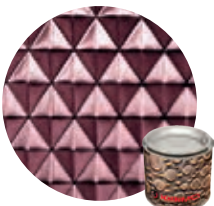

4004
patina pembe / patina pink
0.25 - 1.00 kg.

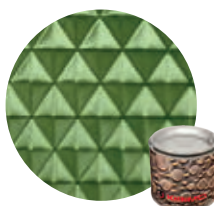

4005
patina yeşil / patina green
0.25 - 1.00 kg.



4006
siyah / black
1.00 - 5.00 - 18.00 kg.



4007
tiner / paint thinner
5.00 - 12.00 kg.

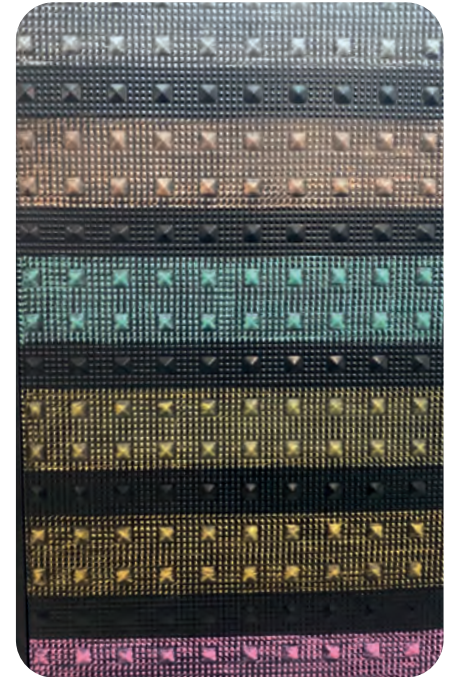

Halkalar - Rings



□ 12x6 mm
düz (smooth)



□ 12x6 mm
izli (hammered)



□ 12x12 mm
düz (smooth)



□ 12x12 mm
izli (hammered)



□ 12x6 mm
izli (hammered)

new
yeni



□ 12x6 mm
düz (smooth)

Kod Code	Ölçü Dimension
2940	Ø80 mm
2941	Ø100 mm
2942	Ø110 mm
2943	Ø120 mm

Kod Code	Ölçü Dimension
2944	Ø80 mm
2945	Ø100 mm
2946	Ø110 mm
2947	Ø120 mm

Kod Code	Ölçü Dimension
2948	Ø100 mm
2949	Ø120 mm
2950	Ø130 mm
2951	Ø150 mm

Kod Code	Ölçü Dimension
2952	Ø100 mm
2953	Ø120 mm
2954	Ø130 mm
2955	Ø150 mm

Kod Code	Ölçü Dimension
2956	Ø100 mm
2957	Ø120 mm

Kod Code	Ölçü Dimension
2956-A	Ø100 mm
2957-A	Ø120 mm

Şişirmeler - Hot Forged Pieces



new
yeni
2550
□ 12 mm
32x90 mm



new
yeni
2551
□ 12 mm
27x125 mm



new
yeni
2552
□ 12 mm
25x150 mm



new
yeni
2553
□ 12 mm
32x150 mm



new
yeni
2554
□ 12 mm
27x160 mm



new
yeni
2555
□ 12 mm
30x170 mm



new
yeni
2556
□ 12 mm
52x170 mm



new
yeni
2557
□ 12 mm
60x164 mm

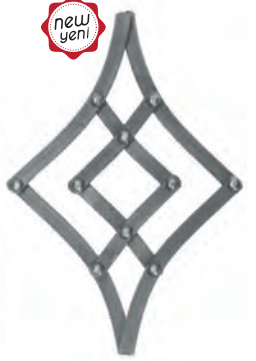

new
yeni
2558
□ 12 mm
185x260 mm

Sıcak Dövme Ara Bağlantı Parçaları - Hot Forged Connection Pieces



3790
33x26 mm
delik/hole: □ 12x12 mm



3791
36x26 mm
delik/hole: □ 14x14 mm



3792
60x35 mm
delik/hole: □ 24x24 mm



3793
33x26 mm
delik/hole: Ø14 mm



3794
33x26 mm
delik/hole: Ø16 mm



3795
50x64 mm
delik/hole: Ø26 mm

Osmanlı Cami Topuzları - Ottoman Mosque Knobs



6050
35x35 mm
delik/hole: Ø12 mm



6050-A
35x35 mm
delik/hole: Ø16 mm



6051
40x40 mm
delik/hole: Ø16 mm



6052
50x50 mm
delik/hole: Ø18 mm



6053
35x35 mm
delik/hole: □ 12x12 mm



6054
40x40 mm
delik/hole: □ 12x12 mm



6054-A
40x40 mm
delik/hole: □ 16x16 mm

Dövme Mızraklar - Forged Spears

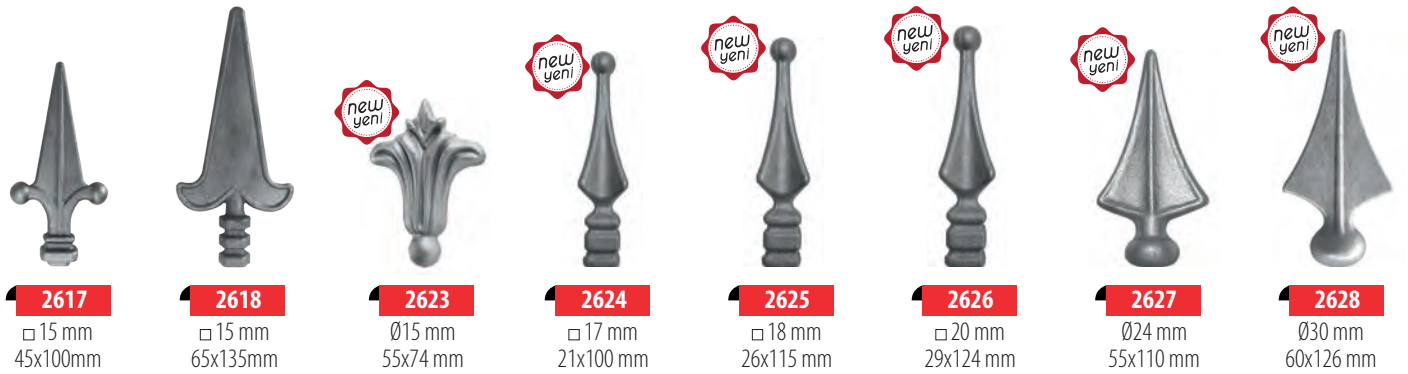
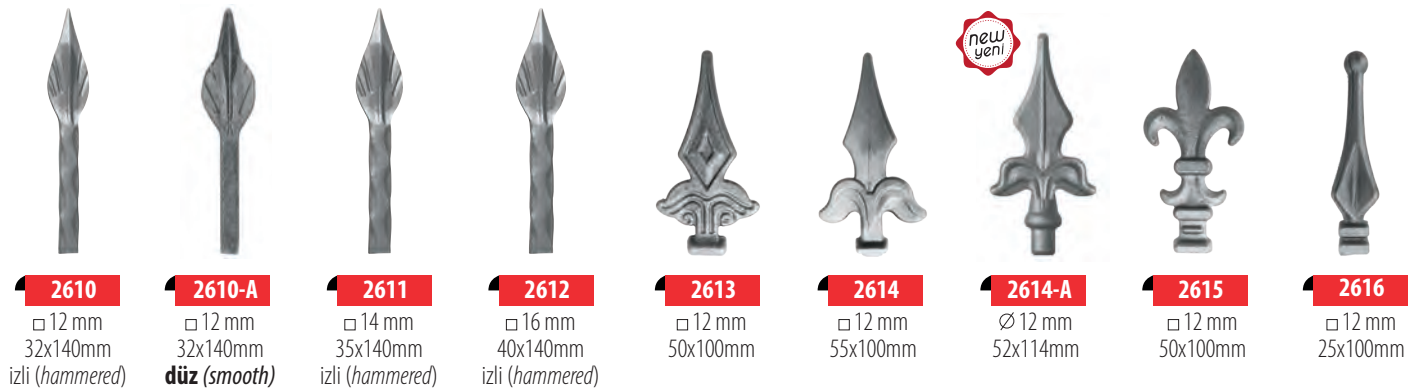
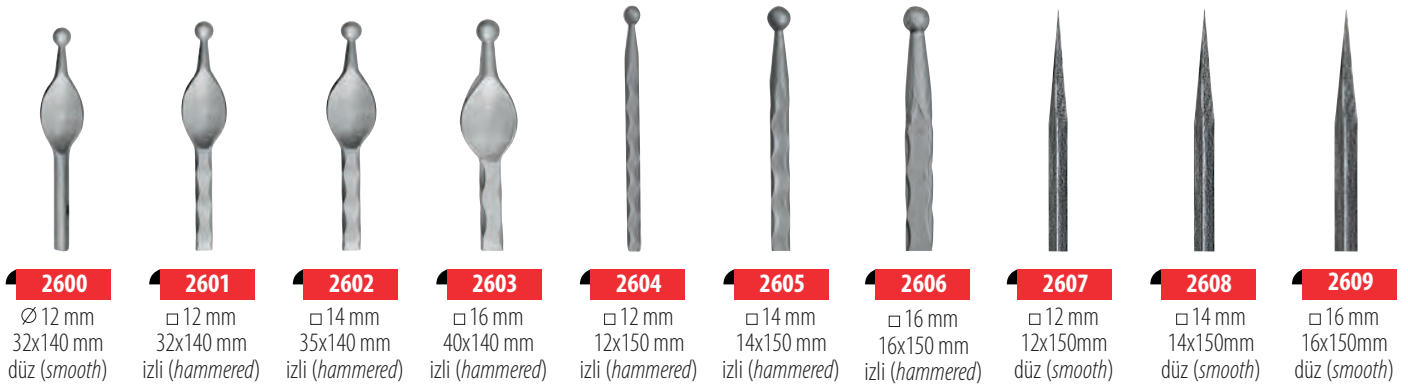

Sac Mızraklar - Sheet Spears

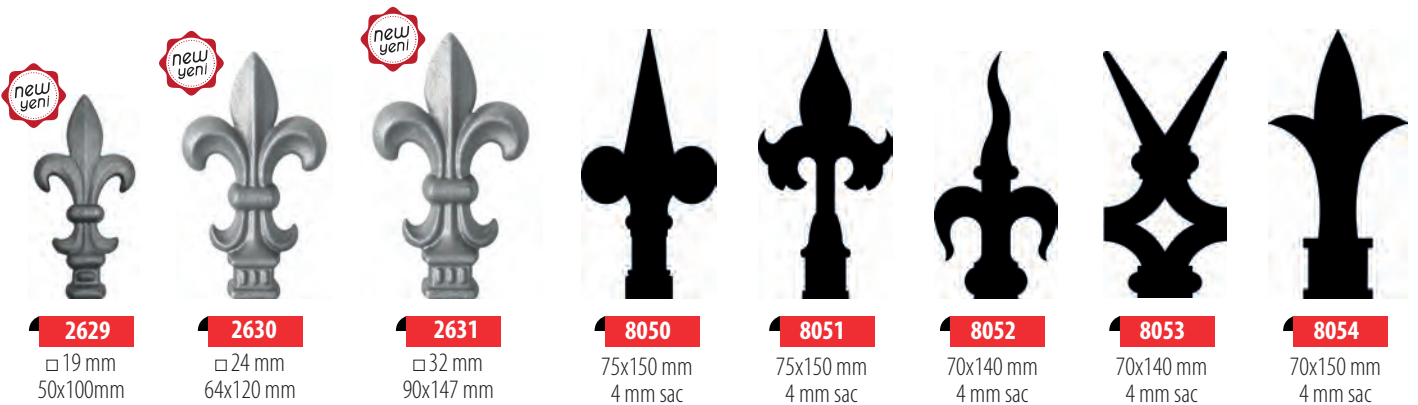

Dekoratif İzli Menteşeler - Decorative Patterned Hinges



Kod Code	Ölçü Dimension	Sac Kalınlığı Thickness
3411	250x135 mm	3 mm
3403	383x207 mm	3 mm
3406	493x227 mm	3 mm



Kod Code	Ölçü Dimension	Sac Kalınlığı Thickness
3411-A	250x135 mm	3 mm
3404	383x207 mm	3 mm
3408	493x227 mm	3 mm



Kod Code	Ölçü Dimension	Sac Kalınlığı Thickness
3405	218x148 mm	3 mm
3420	354x206 mm	3 mm
3418	498x270 mm	3 mm



Kod Code	Ölçü Dimension	Sac Kalınlığı Thickness
3405-A	218x148 mm	3 mm
3421	354x206 mm	3 mm
3419	498x270 mm	3 mm



Kod Code	Ölçü Dimension	Sac Kalınlığı Thickness
3412	232x131 mm	3 mm
3409	350x200 mm	3 mm
3416	522x225 mm	3 mm



Kod Code	Ölçü Dimension	Sac Kalınlığı Thickness
3412-A	232x131 mm	3 mm
3410	350x200 mm	3 mm
3417	522x225 mm	3 mm

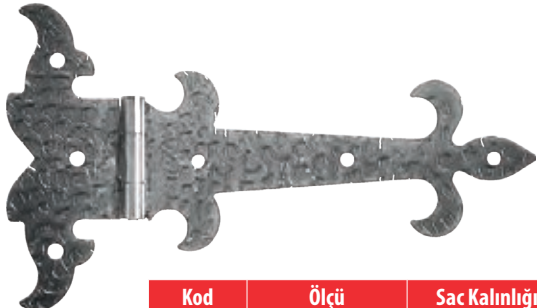

Kod Code	Ölçü Dimension	Sac Kalınlığı Thickness
3442	203x100 mm	3 mm
3439	350x200 mm	3 mm
3443	525x225 mm	3 mm



Kod Code	Ölçü Dimension	Sac Kalınlığı Thickness
3442-A	203x100 mm	3 mm
3440	350x200 mm	3 mm
3444	525x225 mm	3 mm

****Dekoratif menteşeler 3mm izli sactan üretilmektedir.**
**Decorative hinges are produced from 3mm thick patterned sheet metal.

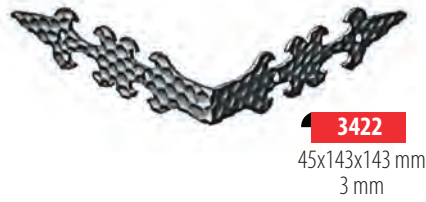
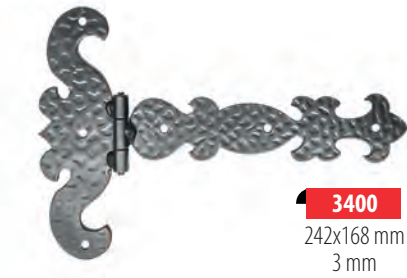
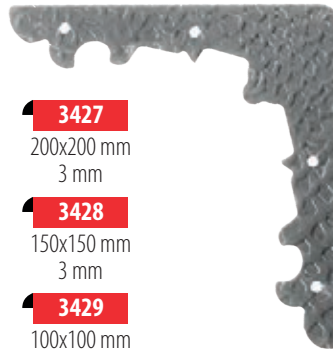
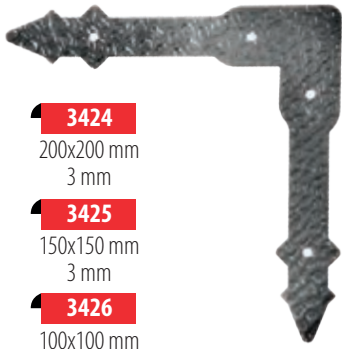

****Dekoratif menteşeler 3mm izli sactan üretilmektedir.**
****Decorative hinges are produced from 3mm thick patterned sheet metal.**



Kapı Aynaları - Door Lock Plates



3950
105x265 mm
3 mm

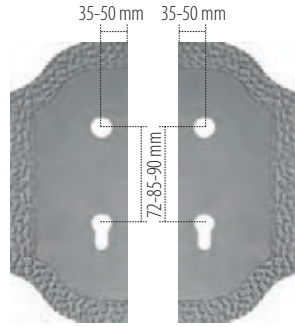

3950-A
105x265 mm
3 mm

3950-B
105x265 mm
3 mm



3951
105x265 mm
2 mm

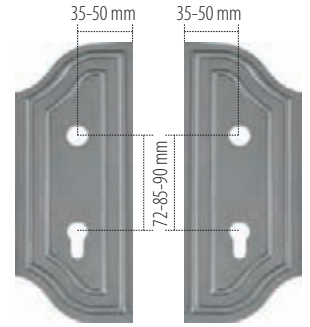

3951-A
105x265 mm
2 mm

3951-B
105x265 mm
2 mm



3952
155x275 mm
2 mm

3953
155x275 mm
2 mm

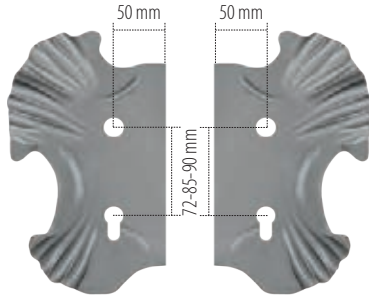

3952-A
155x275 mm
2 mm

3953-A
155x275 mm
2 mm

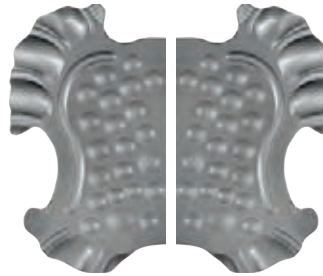

3954
155x275 mm
2 mm

3955
155x275 mm
2 mm

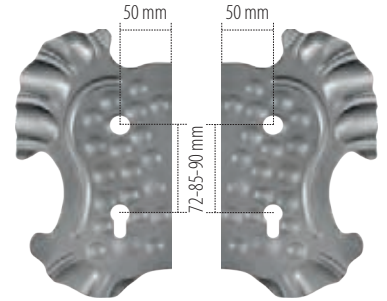

3954-A
155x275 mm
2 mm

3955-A
155x275 mm
2 mm



3956
120x315 mm
2 mm

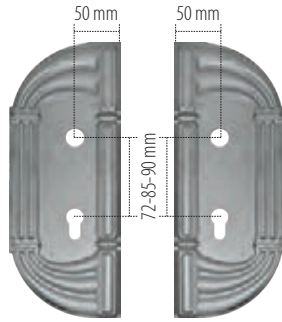

3956-A
120x315 mm
2 mm

3956-B
120x315 mm
2 mm



3957
135x305 mm
3 mm

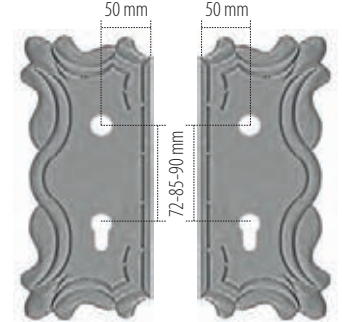

3957-A
135x305 mm
3 mm

3957-B
135x305 mm
3 mm



3958
90x295 mm
3 mm

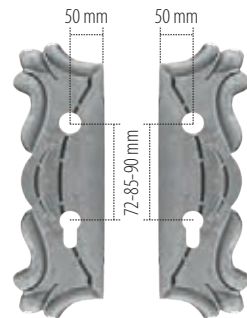

3958-A
90x295 mm
3 mm

3958-B
90x295 mm
3 mm

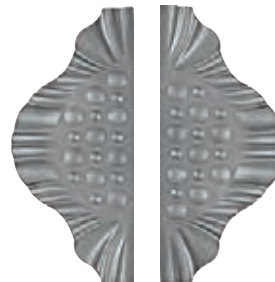

3960
115x280 mm
2 mm

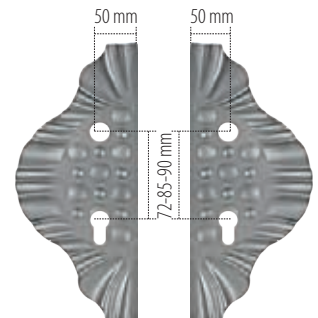

3960-A
115x280 mm
2 mm

3960-B
115x280 mm
2 mm

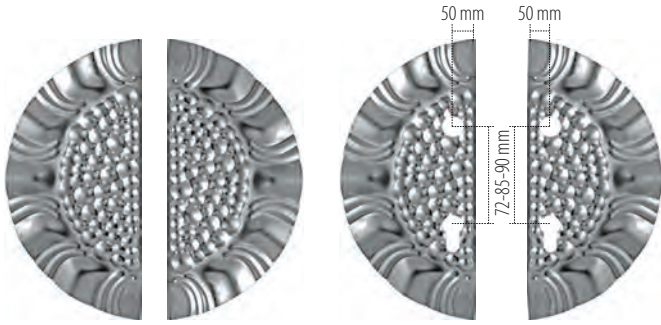

3961
125x265 mm
1 mm

3961-A
125x265 mm
1 mm

3961-B
125x265 mm
1 mm

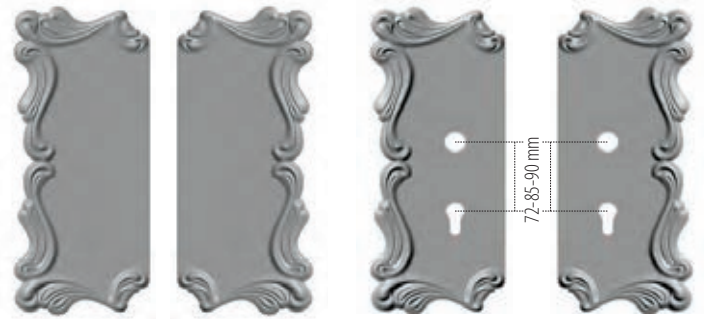

3964
133x318 mm
2 mm

3964-A
133x318 mm
2 mm

3964-B
133x318 mm
2 mm

Kilit Karşılıkları - Lock Plates

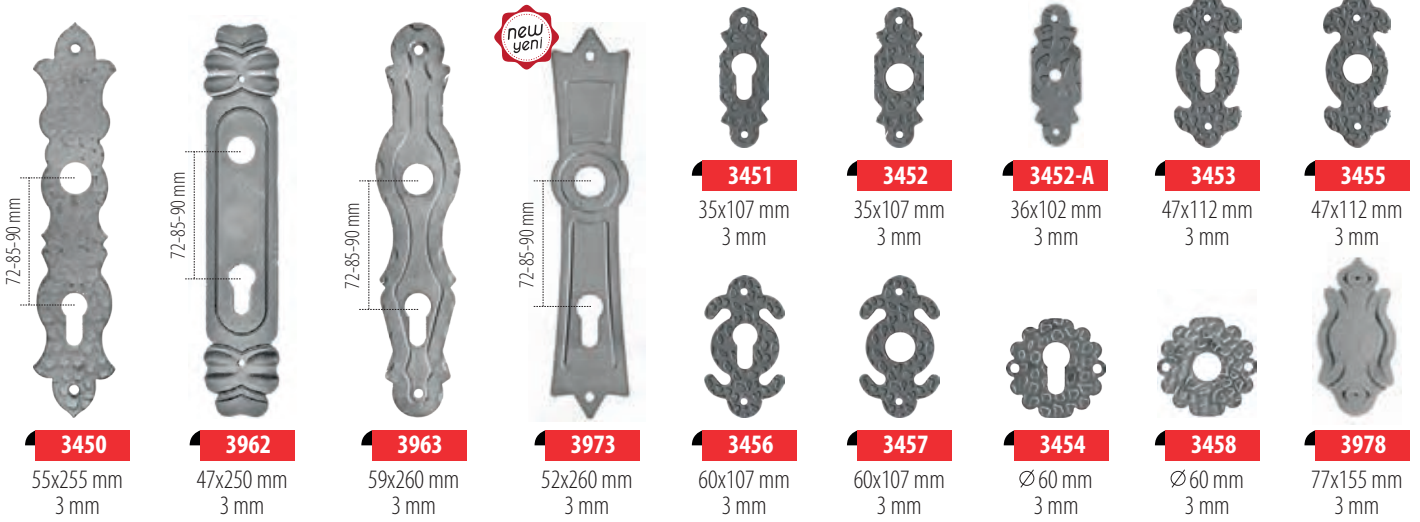

3450
72-85-90 mm
55x255 mm
3 mm

3962
72-85-90 mm
47x250 mm
3 mm

3963
72-85-90 mm
59x260 mm
3 mm

3973
72-85-90 mm
52x260 mm
3 mm

3451
35x107 mm
3 mm

3452
35x107 mm
3 mm

3452-A
36x102 mm
3 mm

3453
47x112 mm
3 mm

3455
47x112 mm
3 mm

3456
60x107 mm
3 mm

3457
60x107 mm
3 mm

3454
Ø 60 mm
3 mm

3458
Ø 60 mm
3 mm

3978
77x155 mm
3 mm

Kapı Tokmakları - Door Knockers

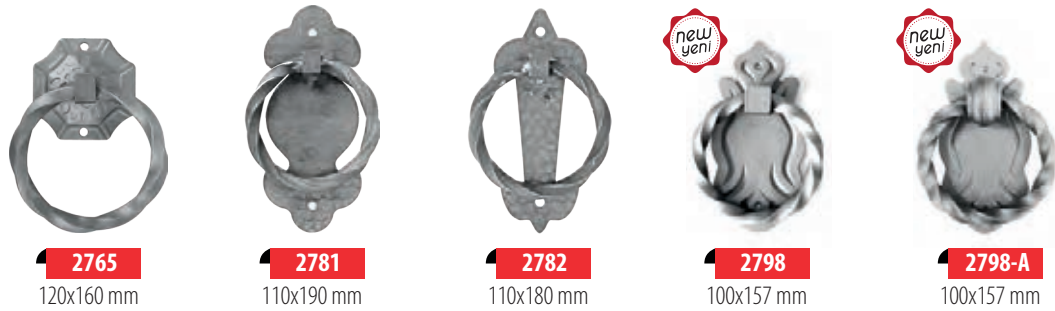

2765
120x160 mm

2781
110x190 mm

2782
110x180 mm

2798
100x157 mm

2798-A
100x157 mm

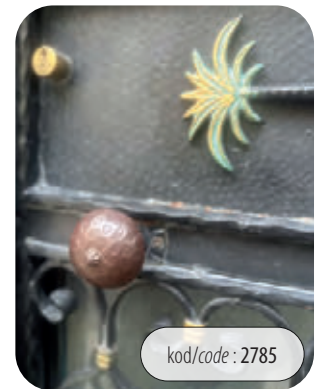

Dekoratif Kapı Kolları - Decorative Door Knobs

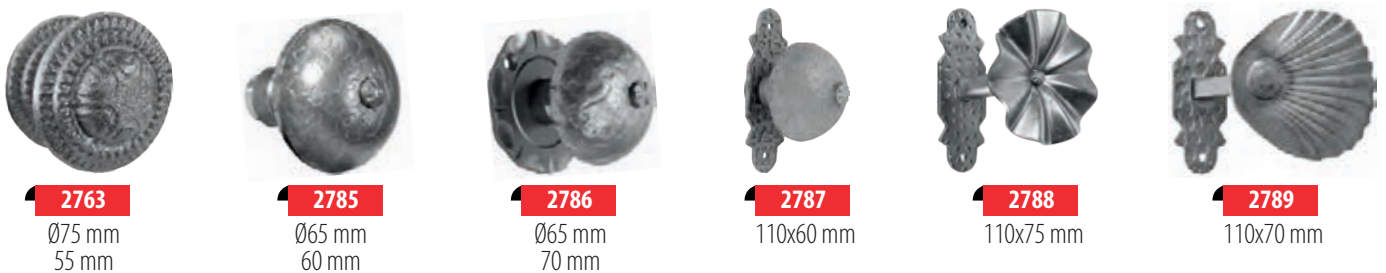

2763
Ø75 mm
55 mm

2785
Ø65 mm
60 mm

2786
Ø65 mm
70 mm

2787
110x60 mm

2788
110x75 mm

2789
110x70 mm

Kollu Kapı Aynaları - Door Lock Plates with Handle



3980
155x275 mm
2 mm



3981
155x275 mm
2 mm

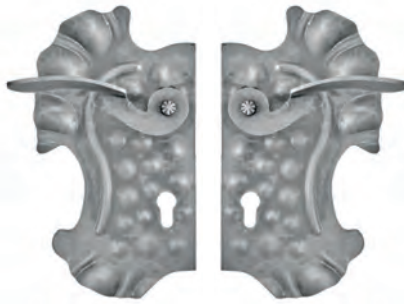

3982
155x275 mm
2 mm



3983
155x275 mm
2 mm

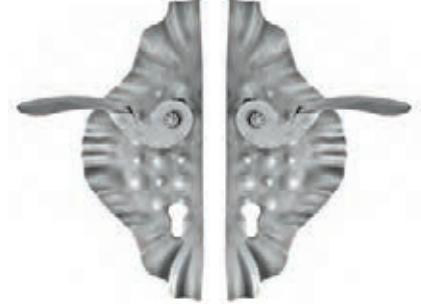

3984
115x280 mm
2 mm



3985
115x280 mm
2 mm



3980-A
155x275 mm
2 mm



3981-A
155x275 mm
2 mm

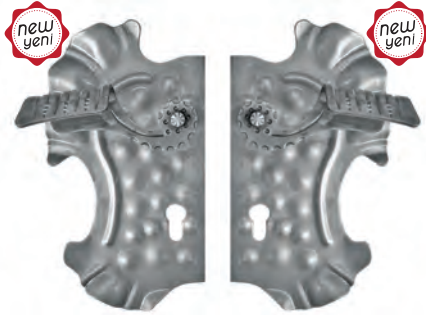

3982-A
155x275 mm
2 mm



3983-A
155x275 mm
2 mm



3984-A
115x280 mm
2 mm



3985-A
115x280 mm
2 mm



3986
55x245 mm
3 mm



3987
55x245 mm
3 mm



3988
47x250 mm
3 mm



3989
47x250 mm
3 mm



2743
105x265 mm
2 mm



2744
105x265 mm
2 mm



3986-A
59x260 mm
3 mm



3987-A
59x260 mm
3 mm



3988-A
47x250 mm
3 mm



3989-A
47x250 mm
3 mm



2796
100x280 mm
3 mm



2797
100x280 mm
3 mm

Dekoratif Kapı Kolları - Decorative Door Handles



2758

95x235 mm
döküm (cast)



2759

80x255 mm
döküm (cast)



2760

80x260 mm
döküm (cast)



2761

110x275 mm



2762

110x360 mm

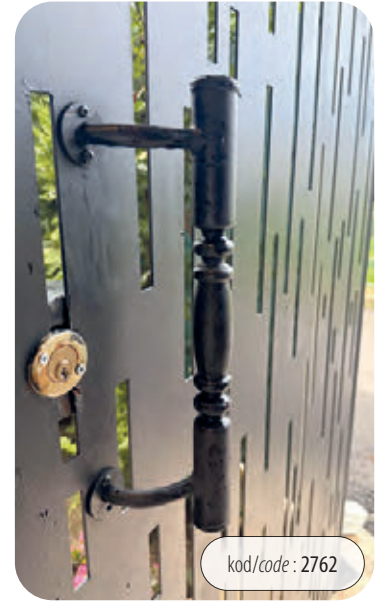

kod/code : 2762



2790

75x675 mm



2776

12x12 mm
90x280 mm



2777

20x10 mm
115x300 mm



2778

12x12 mm
50x210 mm



2795

75x390 mm



kod/code : 2742



2793

60x240 mm



2791

□ 12 mm
59x260 mm



2792

□ 12 mm
47x250 mm



new
yeni

2740

□ 12 mm
52x260 mm



new
yeni

2741

47x250 mm



new
yeni

2742

52x260 mm

Dekoratif Kapı Kolları - Decorative Door Handles



2767
85x160 mm



2768
85x125 mm



2769
80x120 mm



2770
85x145 mm



2771
80x140 mm



2772
70x130 mm



2773
55x145 mm



2773-A
55x145 mm



2774
60x130 mm



2775
75x140 mm



2779
70x150 mm



2780
70x150 mm

Kapı Kolu Milleri - Door Handle Spindle Serrated



galvanizli
galvanized

4113
8x90 mm

4114
8x100 mm

4115
8x120 mm

****Dekoratif kapı kolları 2'li set halinde satılmaktadır ve beyaz galvaniz kaplamalıdır.**
****Decorative door handles are sold in sets of two and have a white galvanized coating.**

Harfler ve Rakamlar - Letters and Numbers



H-100
h: 100 mm
3 mm

H-150
h: 150 mm
3 mm



KH-50
h: 50 mm
3 mm



R-100
h: 100 mm
3 mm

R-150
h: 150 mm
3 mm

****Harfler ve rakamlar izli sactan üretilmektedir.**
****Letters and numbers are produced by patterned sheet.**



kod/code : 2772

Yaylı Sürgüler - Padlock Bolts

Yaylı Sürgü
Padlock Bolt with Spring

Kod Code	Ölçü Dimension	Kg.	Paket Package
4100	22x3x120 mm	0.22	45
4101	26x3x150 mm	0.28	25
4102	30x4x200 mm	0.50	20
4103	30x4x250 mm	0.56	20
4104	30x4x300 mm	0.64	20
4106	30x4x400 mm	0.82	20
4108	30x4x500 mm	1.00	20
4110	30x4x600 mm	1.18	20

Ekonomik Yaylı Sürgü
Eco-Padlock Bolt with Spring

Kod Code	Ölçü Dimension	Kg.	Paket Package
4116	30x2.5x130 mm	0.14	40
4117	30x2.5x150 mm	0.20	30
4118	30x2.5x200 mm	0.24	25

Demirci Sürgüsü
Sliding Bolt

Kod Code	Ölçü Dimension	Kg.	Paket Package
4119	40x85 mm	0.16	12
4120	40x120 mm	0.23	12

Kepli ve Pimli Makaralar - Wheel with Iron Pin 2 Bearings (V+U) form

Kepli-Çift Rulmanlı Makara



Kod Code	Ölçü Dimension	Kg.	Paket Package
4130	Ø40x20 mm	0.16	12
4131	Ø50x20 mm	0.27	12
4132	Ø60x28 mm	0.53	20
4133	Ø70x28 mm	0.70	20
4134	Ø80x28 mm	1.00	12
4135	Ø90x28 mm	1.30	8
4136	Ø100x28 mm	1.60	8

Pimli-Çift Rulmanlı Yedek Makara



Kod Code	Ölçü Dimension	Kg.	Paket Package
4140	Ø40x20 mm	0.11	12
4141	Ø50x20 mm	0.18	12
4142	Ø60x28 mm	0.33	12
4143	Ø70x28 mm	0.50	12
4144	Ø80x28 mm	0.69	8
4145	Ø90x28 mm	0.96	8
4146	Ø100x28 mm	1.22	8

Denge Sacı ve Makaralar - Guides & Guide Plates

Denge Makarası (civatalı)
Guides & Guide Plates (with pin bolt)

Kod Code	Ölçü Dimension	Kg.	Paket Package
4170	Ø25x38 mm	0.09	20
4171	Ø35x38 mm	0.12	20
4172	Ø38x59 mm	0.16	15

Denge Makarası Pimli (Plastik)
Plastic Guide with Iron Pin (For Welding)

Kod Code	Ölçü Dimension	Kg.	Paket Package
4173	Ø35x38 mm	0.10	100
4174	Ø38x59 mm	0.14	100

Denge Makarası-Pro (civatalı)
Plastic Guide-Pro-With Screw

Kod Code	Ölçü Dimension	Kg.	Paket Package
4178	39x49 mm M12	0.15	20
4179	39x56 mm M14	0.24	15

Kapı Üstü Mandalı
Throw Over Loop with Handle

Kod Code	Ölçü Dimension	Kg.	Paket Package
4182	30'luk profil	0.17	25
4183	40'luk profil	0.18	25

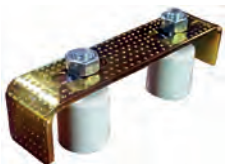
2'li Denge Seti
Single Plate with 2 Guides

Kod Code	Ölçü Dimension	Kg.	Paket Package
4190	Ø39x49 mm	0.47	25

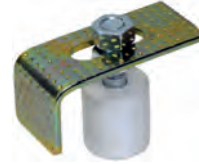
Tekli Denge Seti
Single Plate with 1 Guide

Kod Code	Ölçü Dimension	Kg.	Paket Package
4192	Ø39x49 mm	0.26	25

Mil Menteşeler - Hinges

 Standart Mil Menteşeler
Standard Hinges

Kod Code	Ölçü Dimension	Kg.	Paket Package
4205	Ø10x50 mm	0.030	60
4206	Ø12x55 mm	0.044	60
4207	Ø14x60 mm	0.068	50
4208	Ø16x70 mm	0.110	25
4209	Ø18x80 mm	0.155	30
4210	Ø20x85 mm	0.200	30
4211	Ø22x90 mm	0.260	20
4212	Ø24x100 mm	0.345	15
4213	Ø26x110 mm	0.445	20
4214	Ø30x150 mm	0.820	30

 Bilyalı Uzun Boy Menteşeler
Hinge with Ball- Long Type

Kod Code	Ölçü Dimension	Kg.	Paket Package
4222	Ø22x200 mm	0.59	24
4223	Ø24x200 mm	0.71	20
4224	Ø26x200 mm	0.83	18
4225	Ø30x200 mm	1.10	14

 Bilyalı Menteşeler
Hinge with Ball Holed

Kod Code	Ölçü Dimension	Kg.	Paket Package
4216	Ø16x120 mm	0.17	30
4217	Ø16x140 mm	0.20	30
4218	Ø18x120 mm	0.22	20
4219	Ø20x120 mm	0.27	20
4220	Ø22x120 mm	0.33	20
4221	Ø24x120 mm	0.40	15

 Ferforje Menteşeler
Decorative Hinge with Ball

Kod Code	Ölçü Dimension	Kg.	Paket Package
4226	Ø16x125 mm	0.17	30
4227	Ø18x135 mm	0.23	24
4228	Ø20x150 mm	0.31	22
4229	Ø22x160 mm	0.41	24
4230	Ø24x180 mm	0.55	20
4231	Ø26x185 mm	0.67	20
4232	Ø30x190 mm	0.90	20

Kanatlı Menteşeler - Side Wing Hinges

 Yaprak Menteşeler
Hinge with 2 wings

Kod Code	Ölçü Dimension	Kg.	Paket Package
4233	40x85x4 mm	0.15	60
4234	50x85x4 mm	0.20	50
4235	60x85x4 mm	0.24	45
4236	70x85x4 mm	0.30	34

 Yandan Tek Sac 2 Uzun Kanatlı Menteşeler
Hinge Side Single Leaf 2 Long Wings

Kod Code	Ölçü Dimension	Kg.	Paket Package
4246	Ø24x162x4 mm	0.72	20
4247	Ø28x162x4 mm	0.92	20

 Yandan Tek Sac 2 Kanatlı Menteşeler
Hinge Side Single Leaf 2 Wings

Kod Code	Ölçü Dimension	Kg.	Paket Package
4237	Ø12x60x2,5 mm	0.069	50
4238	Ø14x66x2,5 mm	0.098	40
4239	Ø16x70x3 mm	0.135	30
4240	Ø17x76x3 mm	0.175	24
4241	Ø19x82x3 mm	0.225	24
4242	Ø24x112x4 mm	0.480	36
4243	Ø28x112x4 mm	0.640	20

 Yandan Tek Sac 3 Kanatlı Menteşeler
Hinge Side Single Leaf 3 Wings

Kod Code	Ölçü Dimension	Kg.	Paket Package
4248	Ø24x164x4 mm	0.72	20
4249	Ø28x164x4 mm	0.92	20

 Yandan Tek Sac 4 Kanatlı Menteşeler
Hinge Side Single Leaf 4 Wings

Kod Code	Ölçü Dimension	Kg.	Paket Package
4244	Ø24x166x4 mm	0.72	20
4245	Ø28x166x4 mm	0.92	20

Yandan Çift Saclı Mentешeler - Hinge Center Double Leaf

Yandan Çift Sac 2 Kanatlı Mentешeler
Hinge With Angle Leaf 2 Wings

Kod Code	Ölçü Dimension	Kg.	Paket Package
4250	Ø12x60x2.5 mm	0.069	50
4251	Ø14x66x2.5 mm	0.098	40
4252	Ø16x70x3 mm	0.135	30
4253	Ø17x76x3 mm	0.175	24
4254	Ø19x82x3 mm	0.225	20
4255	Ø24x112x4 mm	0.480	30
4256	Ø28x112x4 mm	0.640	20

Yandan Çift Sac 3 Kanatlı Mentешeler
Hinge With Angle Leaf 3 Wings

Kod Code	Ölçü Dimension	Kg.	Paket Package
4259	Ø24x164x4 mm	0.72	20
4260	Ø28x164x4 mm	0.92	20

Yandan Çift Sac 2 Uzun Kanatlı Mentешeler
Hinge Side Double Leaf 2 Long Wings

Kod Code	Ölçü Dimension	Kg.	Paket Package
4257	Ø24x166x2 mm	0.71	20
4258	Ø28x162x4 mm	0.93	20

Yandan Çift Sac 4 Kanatlı Mentешeler
Hinge With Angle Leaf 4 Wings

Kod Code	Ölçü Dimension	Kg.	Paket Package
4261	Ø24x166x4 mm	0.72	20
4262	Ø28x166x4 mm	0.92	20

Merkezden Açılır Mentешeler - Center Opening Hinges

Merkezden Açılır 2 Kanatlı Mentешeler
Center Opening with 2 Wings

Kod Code	Ölçü Dimension	Kg.	Paket Package
4263	Ø24x112x4 mm	0.52	15
4264	Ø28x112x4 mm	0.625	15

Merkezden Açılır 3 Kanatlı Mentешeler
Center Opening with 3 Wings

Kod Code	Ölçü Dimension	Kg.	Paket Package
4267	Ø24x164x4 mm	0.75	15
4268	Ø28x164x4 mm	0.91	15

Merkezden Açılır 2 Uzun Kanatlı Mentешeler
Center Opening with 2 Long Wings

Kod Code	Ölçü Dimension	Kg.	Paket Package
4265	Ø24x162x4 mm	0.75	15
4266	Ø28x162x4 mm	0.92	15

Merkezden Açılır 4 Kanatlı Mentешeler
Center Opening with 4 Wings

Kod Code	Ölçü Dimension	Kg.	Paket Package
4269	Ø24x166x4 mm	0.75	15
4270	Ø28x166x4 mm	0.91	15

Pencere Mandalları - Window Latches

Pencere Mandalı
Window Latch

Kod Code	Ölçü Dimension	Kg.	Paket Package
4372	63x2x80 mm	0.06	70

new
yeniPencere Mandalı
Window Latch

Kod Code	Ölçü Dimension	Kg.	Paket Package
4372-A	75x140 mm	0.30	5

Profesyonel Makara Grubu - Wheels

1 Rulman Dış Sac V Kanallı Makara
Wheel With Side Support 1 Bearing (V) Form



Kod Code	Ölçü Dimension	Kg.	Paket Package
4271	Ø60x17 mm	0.30	8
4272	Ø70x17 mm	0.42	8
4273	Ø80x20 mm	0.71	6
4274	Ø100x20 mm	1.21	4
4275	Ø120x22 mm	1.89	6

1 Rulman Dış Sac U Kanallı Makara
Wheel With Side Support 1 Bearing (U) Form



Kod Code	Ölçü Dimension	Kg.	Paket Package
4277	Ø60x17 mm	0.30	8
4278	Ø70x17 mm	0.42	8
4279	Ø80x20 mm	0.71	6
4280	Ø100x20 mm	1.21	4
4281	Ø120x22 mm	1.89	6

1 Rulman Dış Sac □ Kanallı Makara
Wheel With Side Support 1 Bearing □ Form



Kod Code	Ölçü Dimension	Kg.	Paket Package
4283	Ø60x17 mm	0.30	8
4284	Ø70x17 mm	0.42	8
4285	Ø80x20 mm	0.71	6
4286	Ø100x20 mm	1.21	4
4287	Ø120x22 mm	1.89	6

2 Rulman Dış Sac V Kanallı Makara
Wheel With Side Support 2 Bearings (V) Form



Kod Code	Ölçü Dimension	Kg.	Paket Package
4289	Ø60x27 mm	0.40	12
4290	Ø70x27 mm	0.61	12
4291	Ø80x30 mm	0.91	8
4292	Ø100x30 mm	1.61	8
4293	Ø120x35 mm	2.66	4

2 Rulman Dış Sac U Kanallı Makara
Wheel With Side Support 2 Bearings (U) Form



Kod Code	Ölçü Dimension	Kg.	Paket Package
4295	Ø60x27 mm	0.40	12
4296	Ø70x27 mm	0.61	12
4297	Ø80x30 mm	0.91	8
4298	Ø100x30 mm	1.61	8
4299	Ø120x35 mm	2.66	4

2 Rulman Dış Sac □ Kanallı Makara
Wheel With Side Support 2 Bearings □ Form



Kod Code	Ölçü Dimension	Kg.	Paket Package
4301	Ø60x27 mm	0.40	12
4302	Ø70x27 mm	0.61	12
4303	Ø80x30 mm	0.91	8
4304	Ø100x30 mm	1.61	8
4305	Ø120x35 mm	2.66	4

1 Rulman Civata V Kanallı Makara
Wheel With Screw 1 Bearing (V) Form



Kod Code	Ölçü Dimension	Kg.	Paket Package
4307	Ø60x17 mm	0.26	8
4308	Ø70x17 mm	0.33	8
4309	Ø80x20 mm	0.59	6
4310	Ø100x20 mm	0.96	4
4311	Ø120x22 mm	1.53	6

1 Rulman Civata U Kanallı Makara
Wheel With Screw 1 Bearing (U) Form



Kod Code	Ölçü Dimension	Kg.	Paket Package
4313	Ø60x17 mm	0.26	8
4314	Ø70x17 mm	0.33	8
4315	Ø80x20 mm	0.59	6
4316	Ø100x20 mm	0.96	4
4317	Ø120x22 mm	1.53	6

1 Rulman Civata □ Kanallı Makara
Wheel With Screw 1 Bearing □ Form



Kod Code	Ölçü Dimension	Kg.	Paket Package
4319	Ø60x17 mm	0.26	10
4320	Ø70x17 mm	0.33	10
4321	Ø80x20 mm	0.59	12
4322	Ø100x20 mm	0.96	12
4323	Ø120x22 mm	1.53	8

2 Rulman Civata V Kanallı Makara
Wheel With Screw 2 Bearings (V) Form



Kod Code	Ölçü Dimension	Kg.	Paket Package
4325	Ø60x27 mm	0.40	12
4326	Ø70x27 mm	0.61	12
4327	Ø80x30 mm	0.91	8
4328	Ø100x30 mm	1.61	8
4329	Ø120x35 mm	2.66	4

2 Rulman Civata U Kanallı Makara
Wheel With Screw 2 Bearings (U) Form



Kod Code	Ölçü Dimension	Kg.	Paket Package
4331	Ø60x27 mm	0.40	12
4332	Ø70x27 mm	0.61	12
4333	Ø80x30 mm	0.91	8
4334	Ø100x30 mm	1.61	8
4335	Ø120x35 mm	2.66	4

2 Rulman Civata □ Kanallı Makara
Wheel With Screw 2 Bearings □ Form



Kod Code	Ölçü Dimension	Kg.	Paket Package
4337	Ø60x27 mm	0.40	12
4338	Ø70x27 mm	0.61	12
4339	Ø80x30 mm	0.91	8
4340	Ø100x30 mm	1.61	8
4341	Ø120x35 mm	2.66	4

Profesyonel Makara Grubu - Wheels



1 Rulman Kepli V Kanallı Makara
Wheel With Support 1 Bearing (V) Form

Kod Code	Ölçü Dimension	Kg.	Paket Package
4343	Ø60x17 mm	0.43	8
4343-A	Ø70x17 mm	0.52	8
4344	Ø80x20 mm	0.87	6
4345	Ø100x20 mm	1.30	4



1 Rulman Kepli U Kanallı Makara
Wheel With Support 1 Bearing (U) Form

Kod Code	Ölçü Dimension	Kg.	Paket Package
4346	Ø60x17 mm	0.43	8
4347	Ø70x17 mm	0.52	8
4348	Ø80x20 mm	0.87	6
4349	Ø100x20 mm	1.30	4



1 Rulman Kepli Kanallı Makara
Wheel With Support 1 Bearing Form

Kod Code	Ölçü Dimension	Kg.	Paket Package
4350	Ø60x17 mm	0.43	8
4351	Ø70x17 mm	0.52	8
4352	Ø80x20 mm	0.87	6
4353	Ø100x20 mm	1.30	4



2 Rulman Trolley V Kanallı Makara
Trolley- 2 Bearings (V) Form

Kod Code	Ölçü Dimension	Kg.	Paket Package
4360	Ø100x30 mm	4.15	2
4361	Ø120x35 mm	7.40	2



2 Rulman Trolley U Kanallı Makara
Trolley- 2 Bearings (U) Form

Kod Code	Ölçü Dimension	Kg.	Paket Package
4363	Ø100x30 mm	4.15	2
4364	Ø120x35 mm	7.40	2



2 Rulman Trolley Kanallı Makara
Trolley- 2 Bearings Form

Kod Code	Ölçü Dimension	Kg.	Paket Package
4366	Ø100x30 mm	4.15	2
4367	Ø120x35 mm	7.40	2



1 Rulman Gömme Sac V Kanallı Makara
Wheel With Inner Support 1 Bearing (V) Form

Kod Code	Ölçü Dimension	Kg.	Paket Package
4354	Ø80x20 mm	0.70	12
4355	Ø90x20 mm	1.00	12
4356	Ø100x20 mm	1.17	12



1 Rulman Gömme Sac U Kanallı Makara
Wheel With Inner Support 1 Bearing (U) Form

Kod Code	Ölçü Dimension	Kg.	Paket Package
4357	Ø80x20 mm	0.70	12
4358	Ø90x20 mm	1.00	12
4359	Ø100x20 mm	1.17	12



1 Rulman Gömme Sac Kanallı Makara
Wheel With Inner Support 1 Bearing Form

Kod Code	Ölçü Dimension	Kg.	Paket Package
4369	Ø80x20 mm	0.70	12
4370	Ø90x20 mm	1.00	12
4371	Ø100x20 mm	1.17	12

Kapi Stoperi - Door Stopper



Kapi Stoperi
Door Stopper

Kod Code	Ölçü Dimension	Kg
4395	60x60x115 mm	0.70

Montaj Aksesuarları - Fixing Elements



8091
5 mm
25x100 mm



8092-A
5 mm
25x100 mm

Kuş Önleyici Profiller - Bird Spikes for Gate and Fence

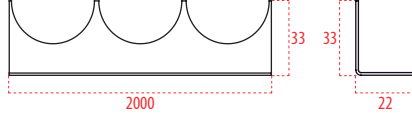

Kuş Önleme Profili-1 (bükümlü)
Bird Spikes for Gate and Fence-1 (bent)

Kod Code	Kalınlık Thickness	Ölçü Dimension	Kg
8083	2 mm	33x22x2000 mm	1.20

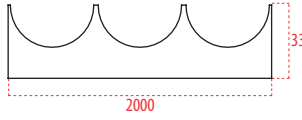

Kuş Önleme Profili-2
Bird Spikes for Gate and Fence-2

Kod Code	Kalınlık Thickness	Ölçü Dimension	Kg
8084	2 mm	33x2000 mm	0.59

Makara Rayları ve 90° Dönüş Rayı - Wheel Tracks and 90° Turning Track

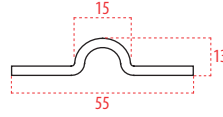

U Kanal Ray (Tek Rulmanlı Makaralara Uygun)
U Channel Track (suitable for 1 bearing wheels)

Kod Code	Ölçü Dimension	Kg	Paket Package
8086	Ø15x2.80x3000 mm	4.00	20

***Kanal çapı 16mm olan tek rulmanlı makaralara uygundur.
***Suitable for single bearing wheels with a channel diameter of 16mm.

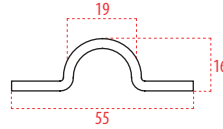

U Kanal Ray (Çift Rulmanlı Makaralara Uygun)
U Channel Track (suitable for 2 bearing wheels)

Kod Code	Ölçü Dimension	Kg	Paket Package
8087	Ø19x3x3000 mm	4.80	20

***Kanal çapı 20mm olan çift rulmanlı makaralara uygundur.
***Suitable for double bearing wheels with a channel diameter of 16mm.

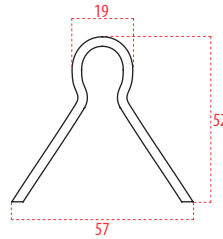

R Kanal Ray
R Channel Track (cement fixing)

Kod Code	Ölçü Dimension	Kg	Paket Package
8088	Ø19x3x3000 mm	8.80	20

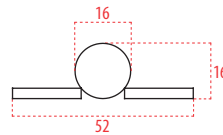

90° Dönüş Rayı
90° Turning Track (radius curved)

Kod Code	Ölçü Dimension	Kg	Paket Package
8089	Ø15x 90° mm	1.95	1

new
yeni

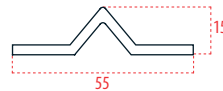

V Kanal Ray
V Channel Track

Kod Code	Ölçü Dimension	Kg	Paket Package
8098	15x55x2.80x3000 mm	4.00	20

C Motifler - Ornamental Scrolls



□ 12x6 mm
izli / hammered
soğuk dövme / cold forged

Kod Code	Ölçü Dimension
22400	80x50 mm
22401	100x60 mm
22403	120x70 mm
22406	130x75 mm
22407	140x80 mm
22408	150x75 mm
22409	160x80 mm
22410	220x130 mm
22411	200x120 mm
22412	250x130 mm



□ 12x6 mm
düz / smooth
soğuk dövme / cold forged

Kod Code	Ölçü Dimension
22450	80x50 mm
22451	100x60 mm
22453	120x70 mm
22456	130x75 mm
22457	140x80 mm
22458	150x75 mm
22459	160x80 mm
22460	220x130 mm
22461	200x120 mm
22462	250x130 mm



□ 12x6 mm
izli / hammered
sıcak dövme / hot forged

Kod Code	Ölçü Dimension
22500	80x50 mm
22501	100x60 mm
22501-A	110x70 mm
22503	120x70 mm
22506	130x75 mm
22507	140x80 mm
22508	150x75 mm
22509	160x80 mm
22510	220x130 mm
22511	200x120 mm
22512	250x130 mm



□ 12x6 mm
düz / smooth
sıcak dövme / hot forged

Kod Code	Ölçü Dimension
22550	80x50 mm
22551	100x60 mm
22551-A	110x70 mm
22553	120x70 mm
22556	130x75 mm
22557	140x80 mm
22558	150x75 mm
22559	160x80 mm
22560	220x130 mm
22561	200x120 mm
22562	250x130 mm



□ 12x12 mm
izli / hammered
sıcak dövme / hot forged

Kod Code	Ölçü Dimension
22580	120x70 mm
22581	120x80 mm
22582	150x85 mm



□ 12x12 mm
düz / smooth
sıcak dövme / hot forged

Kod Code	Ölçü Dimension
22590	120x70 mm
22591	120x80 mm
22592	150x85 mm



sıcak dövme / hot forged



soğuk dövme / cold forged



□ 12x6 mm
izli / hammered
sıcak dövme / hot forged

Kod Code	Ölçü Dimension
22900	60x120 mm



□ 12x6 mm
izli / hammered
sıcak dövme / hot forged

Kod Code	Ölçü Dimension
22901	60x120 mm



□ 12x6 mm
düz / smooth
sıcak dövme / hot forged

Kod Code	Ölçü Dimension
22900-A	60x120 mm
22900-B	80x120 mm



□ 12x6 mm
izli / hammered
sıcak dövme / hot forged

Kod Code	Ölçü Dimension
22902	100x150 mm



□ 12x6 mm
düz / smooth
sıcak dövme / hot forged

Kod Code	Ölçü Dimension
22902-A	100x150 mm



2821
□ 12x6 mm
110x150 mm
izli / hammered



23062
□ 16x7 mm
90x180 mm
düz / smooth



2822
□ 12x6 mm
160x230 mm
izli / hammered



2823
□ 12x6 mm
90x340 mm
izli / hammered



23066
□ 16x7 mm
180x290 mm
düz / smooth



23067
□ 16x7 mm
210x300 mm
düz / smooth



22563
□ 12x6 mm
180x300 mm
düz / smooth



22564
□ 12x6 mm
180x300 mm
düz / smooth

sıcak dövme / hot forged sıcak dövme / hot forged



29143
□ 12x6 mm
120x170 mm
izli / hammered
sıcak dövme / hot forged



23018
□ 12x6 mm
100x150 mm
izli / hammered



23019
□ 12x6 mm
100x150 mm
izli / hammered



23022
□ 12x6 mm
140x190 mm
izli / hammered



23023
□ 12x6 mm
140x190 mm
izli / hammered



23020
□ 12x6 mm
130x200 mm
düz / smooth



23021
□ 12x6 mm
130x200 mm
düz / smooth



23076
□ 16x7 mm
105x210 mm
düz / smooth



23077
□ 16x7 mm
105x210 mm
düz / smooth

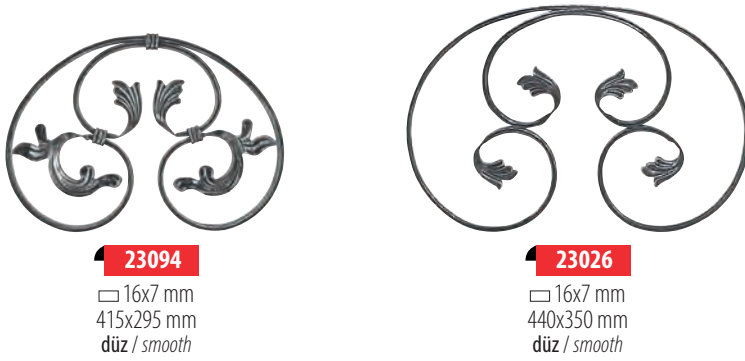
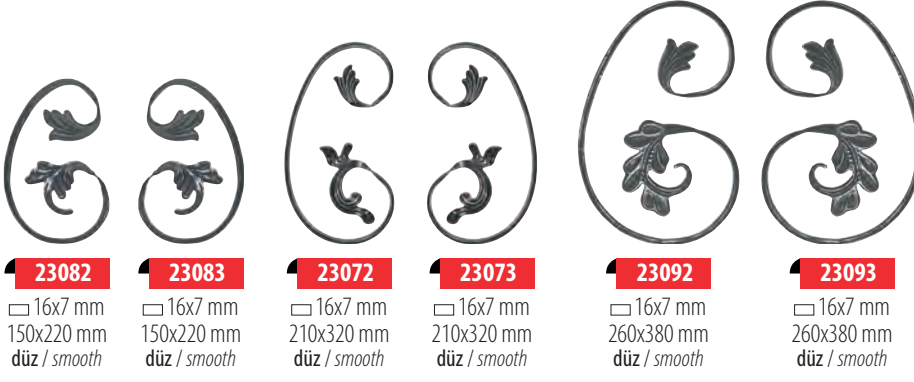

S Motifler - Ornamental Scrolls

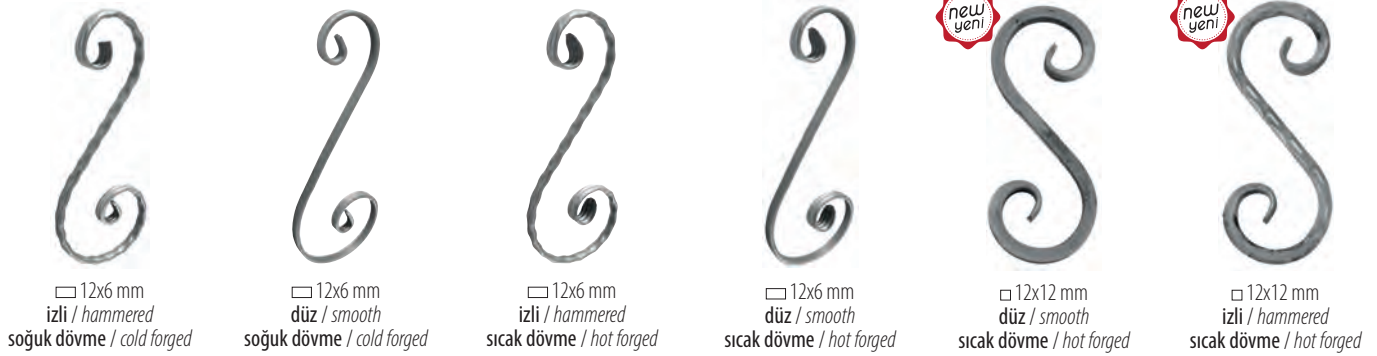

Kod Code	Ölçü Dimension
22600	150x70 mm
22601	170x80 mm
22605	200x85 mm
22606	220x100 mm
22607	230x115 mm
22608	260x115 mm
22609	270x110 mm
22610	280x120 mm
22611	300x120 mm
22612	330x130 mm
22613	360x120 mm

Kod Code	Ölçü Dimension
22650	150x70 mm
22651	170x80 mm
22655	200x85 mm
22656	220x100 mm
22657	230x115 mm
22658	260x115 mm
22659	270x110 mm
22660	280x120 mm
22661	300x120 mm
22662	330x130 mm
22663	360x120 mm

Kod Code	Ölçü Dimension
22700	150x70 mm
22701	170x80 mm
22705	200x85 mm
22706	220x100 mm
22707	230x115 mm
22708	260x115 mm
22709	270x110 mm
22710	280x120 mm
22711	300x120 mm
22712	330x130 mm
22713	360x120 mm

Kod Code	Ölçü Dimension
22750	150x70 mm
22751	170x80 mm
22755	200x85 mm
22756	220x100 mm
22757-A	230x75 mm
22757	230x115 mm
22708-A	250x115 mm
22758	260x115 mm
22759	270x110 mm
22760	280x120 mm
22761	300x120 mm
22761-A	310x115 mm
22762	330x130 mm
22763	360x120 mm
22764	380x120 mm

Kod Code	Ölçü Dimension
22770	80x230 mm
22771	120x310 mm
22772	120x380 mm

Kod Code	Ölçü Dimension
22777	80x230 mm
22778	120x310 mm
22779	120x380 mm
22780	165x450 mm



□ 12x6 mm
izli / hammered
sıcak dövme / hot forged

Kod Code	Ölçü Dimension
22905	60x260 mm
22906	80x380 mm



□ 12x6 mm
düz / smooth
sıcak dövme / hot forged

Kod Code	Ölçü Dimension
22908	80x460 mm



□ 12x6 mm
izli / hammered

Kod Code	Ölçü Dimension
22809	75x260 mm soğuk dövme / cold forged
22909	75x260 mm sıcak dövme / hot forged



□ 12x6 mm

Kod Code	Ölçü Dimension
22815	100x185 mm düz / smooth
22915	100x185 mm izli / hammered



22911
□ 12x6 mm
250x200 mm
düz / smooth
sıcak dövme / hot forged



23000
□ 12x6 mm
100x170 mm



23001
□ 12x6 mm
100x170 mm



23050
□ 12x6 mm
130x300 mm



23051
□ 12x6 mm
130x300 mm



23054
□ 12x6 mm
150x350 mm



23055
□ 12x6 mm
150x350 mm



23002
□ 16x7 mm
140x400 mm



23003
□ 16x7 mm
140x400 mm



23056
□ 16x7 mm
210x410 mm



23057
□ 16x7 mm
210x410 mm



23058
□ 16x7 mm
210x410 mm



23059
□ 16x7 mm
210x410 mm

Kozalaklar & Kozalaklı Çubuklar - Baskets & Basket Bars



2707
□ 10 mm
43x120 mm



2700
□ 12 mm
60x130 mm



2701
□ 14 mm
65x150 mm



2702
□ 16 mm
65x160 mm



2703
□ 20 mm
95x200 mm



2704
□ 24 mm
100x240 mm



2710
□ 12x12 mm
60x800 mm
burgulu (twisted)



2711
□ 12x12 mm
60x800 mm
burgulu (twisted)



2712
□ 12x12 mm
60x800 mm
burgulu (twisted)



2713
□ 12x12 mm
60x800 mm
burgulu (twisted)



2714
□ 12x12 mm
60x800 mm
izli (hammered)



2715
□ 12x12 mm
60x800 mm
izli (hammered)

Cumbalar - Window & Balcony Balustrades



2400
□ 14x14 mm
170x600 mm
800 mm



2401
□ 14x14 mm
170x600 mm
800 mm



2405
□ 12x12 mm
170x700 mm
800 mm



2406
□ 12x12 mm
170x700 mm
800 mm



2406-A
□ 12x12 mm
170x700 mm
800 mm



2407
□ 12x12 mm
170x600 mm
800 mm



2412
□ 12x12 mm
100x520 mm
800 mm



2413
□ 12x12 mm
170x700 mm
1250 mm
düz / smooth



2414
□ 12x12 mm
170x380 mm
800 mm



2415
□ 12x12 mm
170x380 mm
800 mm



2416
□ 12x12 mm
100x520 mm
800 mm



2417
□ 12x12 mm
100x520 mm
800 mm
izli / hammered



kod/code : 2407

Baba Demirler - Beginning Bars of Stairs



21100
□ 24 mm
1200 mm



21104
□ 24 mm
1200 mm



21108
□ 24 mm
1200 mm



21109
□ 24 mm
1200 mm



21110
□ 24 mm
1200 mm



21123
□ 24 mm
1200 mm



21132
□ 30 mm
1200 mm





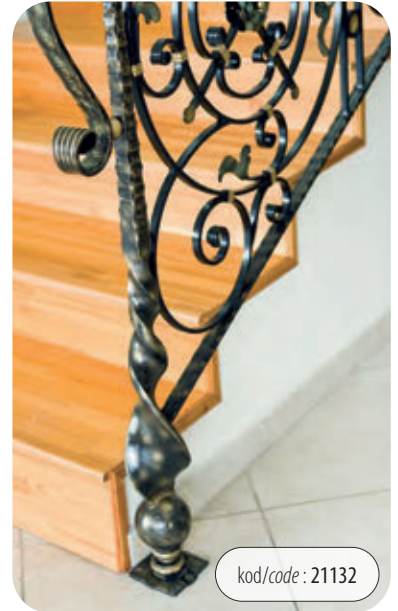





























25529
□ 16 mm
900 mm



kod/code : 21132

Sıcak Dövme Motifli Çubuklar - Hot Forged Bars

								
2350 □ 14x14 mm 75x400 mm 900 mm	2351 □ 14x14 mm 75x240 mm 900 mm	2352 □ 14x14 mm 75x350 mm 900 mm	2353 □ 14x14 mm 38x285 mm 900 mm düz (smooth)	2354 □ 14x14 mm 38x650 mm 900 mm düz (smooth)	2355 Ø 14 mm 40x285 mm 900 mm düz (smooth)	2356 Ø 14 mm 40x650 mm 900 mm düz (smooth)	2358 □ 12x12 mm 38x285 mm 900 mm izli (hammered)	2359 □ 12x12 mm 38x680 mm 900 mm izli (hammered)
								
2360 □ 12x12 mm 30x340 mm 900 mm	2361 □ 12x12 mm 30x600 mm 900 mm	2362 □ 12x12 mm 900 mm	2363 □ 12x12 mm 900 mm	2364 □ 12x12 mm 900 mm	2365 □ 12x12 mm 900 mm	2366 □ 12x12 mm 36x270 mm 900 mm	2367 □ 12x12 mm 30x480 mm 900 mm	
								
2360-A □ 14x14 mm 30x340 mm 900 mm	2361-A □ 14x14 mm 30x600 mm 900 mm	2362 □ 12x12 mm 900 mm	2363 □ 12x12 mm 900 mm	2364 □ 12x12 mm 900 mm	2365 □ 12x12 mm 900 mm	2366 □ 12x12 mm 36x270 mm 900 mm	2367 □ 12x12 mm 30x480 mm 900 mm	
								
2368 □ 12x12 mm 32x90 mm 900 mm	2369 □ 12x12 mm 32x480 mm 900 mm	2370 □ 12x12 mm 27x155 mm 900 mm	2371 □ 12x12 mm 27x550 mm 900 mm	2373 □ 12x12 mm 23x160 mm 900 mm	2373-A □ 12x12 mm 23x530 mm 900 mm	2374 □ 12x12 mm 25x155 mm 900 mm	2375 □ 12x12 mm 25x530 mm 900 mm	



2376

□ 12x12 mm
55x200 mm
900 mm



2377

□ 12x12 mm
55x600 mm
900 mm



2378

□ 12x12 mm
61x200 mm
900 mm



2379

□ 12x12 mm
61x600 mm
900 mm

new
yen!



2387

□ 14x14 mm
38x680 mm
900 mm

new
yen!



2388

□ 14x14 mm
38x700 mm
900 mm



2389

□ 12x12 mm
250x720 mm



2390

□ 12x6 mm
295x800 mm



2394

□ 12x12 mm
240x900 mm



2395

□ 12x12 mm
200x900 mm



2396

□ 16x7 mm
195x630 mm
900 mm



2397

□ 12x12 mm
310x900 mm



2398

Ø12 mm
310x900 mm



2399

□ 12x6 mm
350x840 mm



2420

□ 12x12 mm
95x340 mm
800 mm



2421

□ 12x12 mm
95x170 mm
800 mm



2422

□ 12x12 mm
95x620 mm
800 mm



2423

□ 12x12 mm
115x335 mm
800 mm



2424

□ 12x12 mm
170x420 mm
800 mm



2425

□ 16x7 mm
120x800 mm



2426

□ 12x12 mm
180x625 mm
800 mm



2428

□ 12x12 mm
140x600 mm
800 mm



2429

□ 12x12 mm
140x600 mm
800 mm



2430

□ 12x12 mm
195x630 mm
800 mm



2431

□ 12x12 mm
200x590 mm
800 mm



2432

□ 12x12 mm
160x520 mm
800 mm



2433

□ 12x6 mm
175x800 mm



2434

□ 12x12 mm
130x640 mm
800 mm



2435

□ 12x12 mm
160x800 mm



2436

□ 12x12 mm
185x630 mm
800 mm

new
yen



2481

□ 12x12 mm
160x400 mm
800 mm



2437

□ 12x12 mm
140x260 mm
800 mm



2438

□ 12x12 mm
140x700 mm
800 mm



2439

□ 12x12 mm
240x740 mm
800 mm

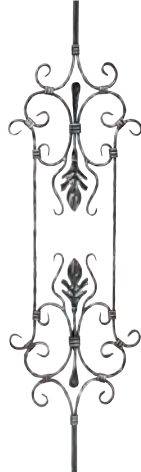

2440

□ 12x12 mm
270x720 mm
800 mm



2441

□ 16x7 mm
155x480 mm
800 mm



2442

□ 16x7 mm
140x700 mm
800 mm



2443

□ 16x7 mm
165x650 mm
800 mm



2444

□ 12x12 mm
140x625 mm
800 mm



new
yen

2444-A

□ 12x12 mm
140x625 mm
800 mm



2445

□ 12x12 mm
170x600 mm
800 mm



2446

□ 12x12 mm
240x470 mm
800 mm



perçinli
(with rivet)



2447

□ 12x12 mm
140x510 mm
800 mm
perçinli (with rivet)



2448

□ 12x12 mm
140x500 mm
800 mm



perçinli
(with rivet)



2449

□ 12x12 mm
145x570 mm
800 mm
perçinli (with rivet)



2450

□ 12x12 mm
145x510 mm
800 mm



2451

□ 12x12 mm
185x590 mm
800 mm

perçinli (with rivet)



2452

□ 12x12 mm
185x590 mm
800 mm



2453

□ 12x12 mm
180x280 mm
800 mm

perçinli (with rivet)



2454

□ 12x12 mm
180x680 mm
800 mm

perçinli (with rivet)

new
yeni



2455

□ 12x12 mm
100x195 mm
800 mm

new
yeni



2456

□ 12x12 mm
100x615 mm
800 mm



2465

□ 16x7 mm
180x800 mm

2465-A

□ 12x6 mm
180x800 mm



2466

□ 16x7 mm
180x800 mm

2466-A

□ 12x6 mm
180x800 mm



2467

□ 12x6 mm
185x800 mm



2468

□ 16x7 mm
275x800 mm



2469

□ 16x7 mm
290x800 mm



2470

□ 16x7 mm
290x800 mm



2471

□ 12x6 mm
290x800 mm

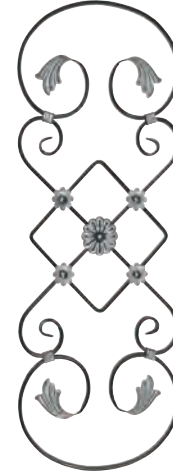

2472

□ 12x6 mm
300x800 mm



2473

□ 16x7 mm
290x530 mm



2474

□ 16x7 mm
290x530 mm



2475

□ 12x12 mm
210x560 mm
800 mm



2482

□ 12x12 mm
240x460 mm
800 mm



2477

□ 16x7 mm
320x740 mm



2478

□ 16x7 mm
320x740 mm



2479

□ 16x7 mm
300x800 mm



2480

□ 16x7 mm
300x800 mm

Ekonomik Ferforje Ürünler - Economic Wrought Iron Products



2800

□ 10x10 mm
230x230 mm
800 mm



2801

□ 12x12 mm
120x300 mm
800 mm



2802

□ 12x12 mm
120x640 mm
800 mm



2803

□ 12x12 mm
160x600 mm
800 mm



2804

□ 12x6 mm
170x800 mm



2805

□ 12x6 mm
180x800 mm
900 mm



2806

□ 12x6 mm
260x750 mm
900 mm



2807

□ 12x12 mm
380x680 mm
800 mm



2808

□ 12x6 mm
300x800 mm



2809

□ 12x6 mm
160x490 mm
800 mm



2810

□ 12x6 mm
190x500 mm
800 mm



2811

□ 12x6 mm
280x620 mm
800 mm



2812

□ 12x6 mm
300x800 mm



2813

□ 12x12 mm
100x190 mm
800 mm



2814

□ 12x12 mm
100x600 mm
800 mm



2815

□ 12x12 mm
150x360 mm
800 mm



2816

□ 12x12 mm
120x600 mm
800 mm



2817

□ 12x12 mm
110x350 mm
800 mm



2818

□ 12x6 mm
190x300 mm
800 mm



2819

□ 12x6 mm
310x640 mm
800 mm



2820

□ 12x6 mm
250x470 mm
800 mm

Üzüm Dalları ve Motifleri - Grapes Rods & Panels



27300

120x180 mm
3 mm
sıcak dövme /
hot forged



27303

80x130 mm
3 mm
soğuk dövme /
cold forged

new
yeni



27301

190 mm



27304

120 mm



27305

140 mm

new
yeni



27316

Ø6 mm
35x220 mm

new
yeni



27317

130x130 mm

10 mm



12 mm

27306

Ø12-Ø10 mm

1100 mm

12 mm



16 mm

27307

Ø16-Ø12 mm

1100 mm

16 mm



20 mm

27308

Ø20-Ø16 mm

1100 mm



27309

Ø14 mm

165x800 mm



27310

Ø14 mm

285x500 mm



27311

Ø14 mm

165x800 mm



27325

Ø11 mm

160x800 mm



27312

Ø14 mm

215x1000 mm

new
yeni



27318

Ø10 mm

200x600 mm



27319

Ø10 mm
240x580 mm



27320

Ø10 mm
270x690 mm



27321

Ø14 mm
200x600 mm
1000 mm



27323

Ø14 mm
270x690 mm
1000 mm



27326

Ø11 mm
150x900 mm



27327

Ø11 mm
300x900 mm



29409

Ø12 mm
370x900 mm



29410

Ø12 mm
300x750 mm



27313

Ø16 - Ø14 - Ø12 mm
1200x800 mm

27314

Ø16 - Ø14 - Ø12 mm
1500x800 mm

Dekoratif Ferforje Paneller - Decorative Wrought Iron Panels



28402

□ 12x12 mm
255x315 mm



28403

□ 12x12 mm
300x375 mm



29109

□ 12x6 mm
240x240 mm



29110

□ 12x6 mm
300x300 mm



29111

□ 12x6 mm
300x300 mm

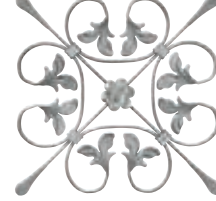

29112

□ 12x6 mm
340x340 mm



29164

□ 12x6 mm
450x450 mm



29156

□ 12x6 mm
240x240 mm



29157

□ 12x6 mm
300x300 mm



29204

□ 16x7 mm
880x370 mm



29601

□ 12x6 mm
880x370 mm

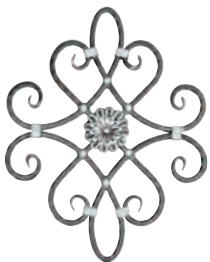

29307

□ 12x12 mm
425x540 mm



29307-A

□ 12x12 mm
425x540 mm

kaynaklı / welded



29307-B

□ 12x6 mm
425x540 mm

kaynaklı / welded

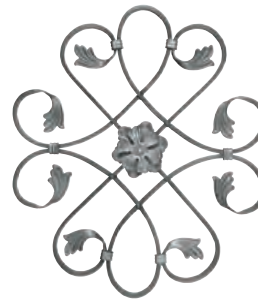

29200

□ 16x7 mm
510x590 mm

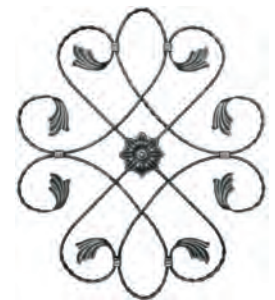

28434

□ 12x6 mm
500x590 mm

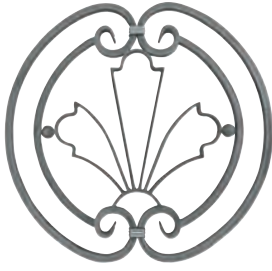

28404
□ 14x14 mm
540x520 mm

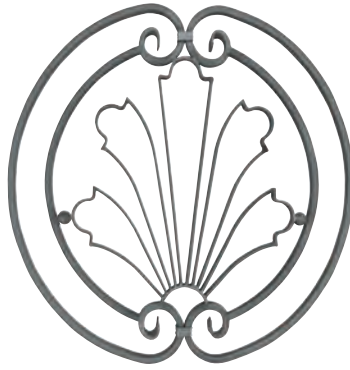

28405
□ 14x14 mm
680x700 mm



28404-A
□ 12x6 mm
340x375 mm

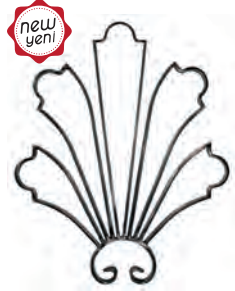

28405-A
□ 12x6 mm
445x530 mm

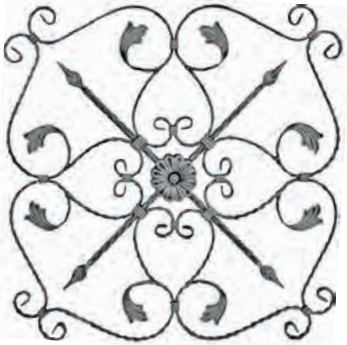

29600
□ 12x6 mm
700x700 mm



29209
□ 16x7 mm
700x700 mm

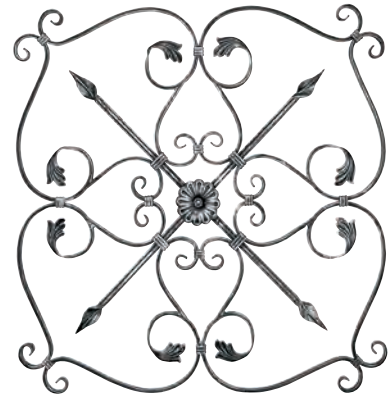

29210
□ 16x7 mm
800x800 mm



29238
□ 12x6 mm
640x640 mm



29201
□ 16x7 mm
670x640 mm



29203
□ 16x7 mm
870x870 mm



2824
□ 12x6 mm
340x90 mm



29100
□ 12x6 mm
520x80 mm



29105-A
□ 12x12 mm
560x80 mm



29301
□ 12x12 mm
385x900 mm



29605
□ 12x6 mm
440x800 mm



28406
□ 16x7 mm
650x700 mm



29224
□ 16x7 mm
700x800 mm

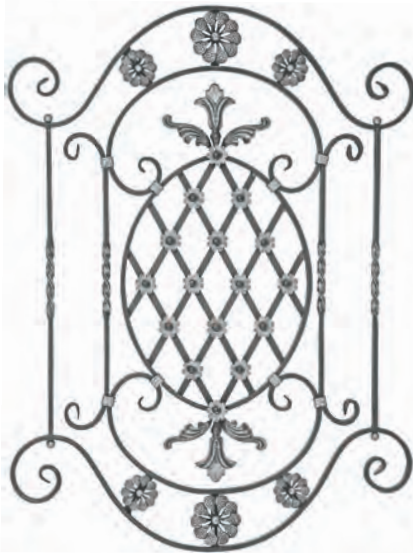

29268
□ 16x7 mm
750x1000 mm



29269
□ 16x7 mm
400x1000 mm



29277
□ 16x7 mm
200x1000 mm



29278
□ 16x7 mm
200x1000 mm



29279
□ 16x7 mm
400x1000 mm



29606
□ 12x6 mm
800x460 mm



29250
□ 16x7 mm
800x570 mm



29246
□ 16x7 mm
800x400 mm



29227
□ 16x7 mm
800x1000 mm



29228
□ 16x7 mm
400x1000 mm



29229
□ 16x7 mm
400x1000 mm

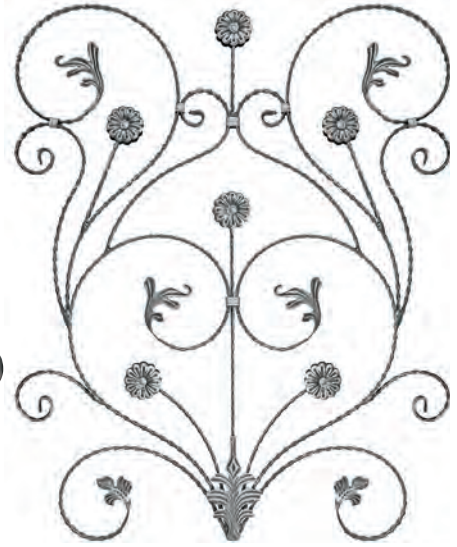

29602
□ 12x6 mm
800x1000 mm

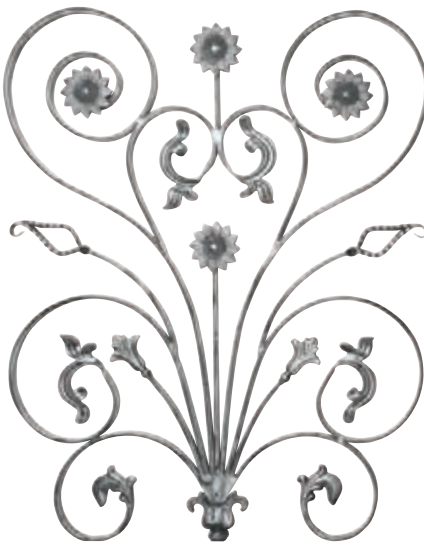

29253
□ 16x7 mm
800x1000 mm



29254
□ 16x7 mm
400x1000 mm



29255
□ 16x7 mm
400x1000 mm



28431
□ 16x7 mm
800x1000 mm



29247
□ 16x7 mm
700x610 mm



29272
□ 16x7 mm
1580x600 mm



29244
□ 16x7 mm
400x1000 mm



29245
□ 16x7 mm
400x1000 mm

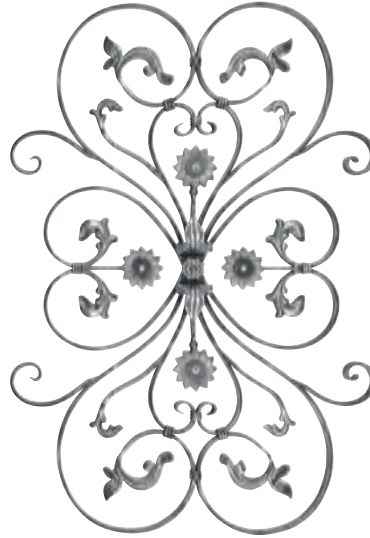

29248
□ 16x7 mm
800x1140 mm



29249
□ 16x7 mm
400x1140 mm

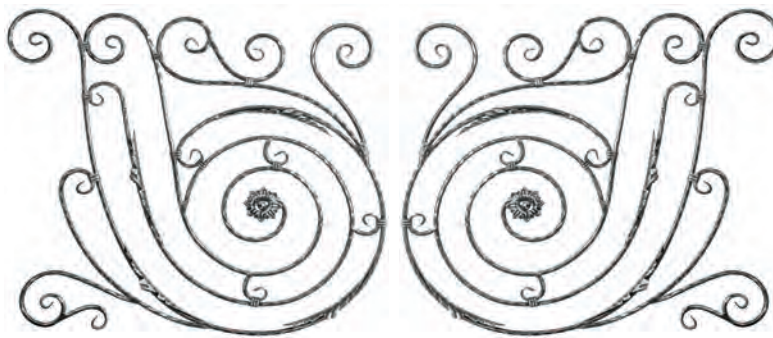

28411
Ø11 mm
940x600 mm



28412
Ø11 mm
940x600 mm



29207
Ø12 mm
750x550 mm



29208
Ø12 mm
750x550 mm

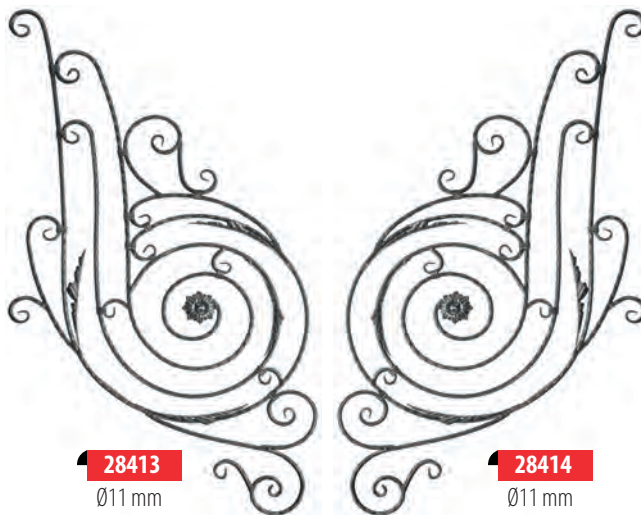

28413
Ø11 mm
785x1085 mm



28414
Ø11 mm
785x1085 mm



28423
Ø11 mm
750x550 mm



28424
Ø11 mm
750x550 mm



28421
Ø11 mm
500x950 mm



28422
Ø11 mm
500x950 mm



28419
Ø11 mm
750x880 mm



28420
Ø11 mm
750x880 mm



29211
Ø12 mm
500x880 mm



29212
Ø12 mm
500x880 mm



29213
Ø12 mm
750x880 mm



29214
Ø12 mm
750x880 mm



28418
Ø11 mm
720x1080 mm



28417
Ø11 mm
720x1080 mm



29206
Ø12 mm
600x1080 mm



29205
Ø12 mm
600x1080 mm

Kapı ve Pencere Başlıkları - Gate and Window Accessories



34100

□ 16x7 mm
1200x220 mm



34102

□ 12x6 mm
1200x220 mm



34104

□ 12x6 mm
740x230 mm



34203

□ 16x7 mm
1510x400 mm



34204

□ 16x7 mm
1510x400 mm



34205

□ 16x7 mm
1270x330 mm



34206

□ 16x7 mm
1270x330 mm

Merdiven Bağlantı Elemanları ve Kıvrımlar - Stair Fitting and Bendings



21303

□ 40x10 mm
100x500 mm



21304

□ 40x10 mm
100x150 mm



21306

□ 40x10 mm
170x320 mm



21117

□ 12x12 mm
95x180 mm



2476

Ø12 mm
70x115 mm

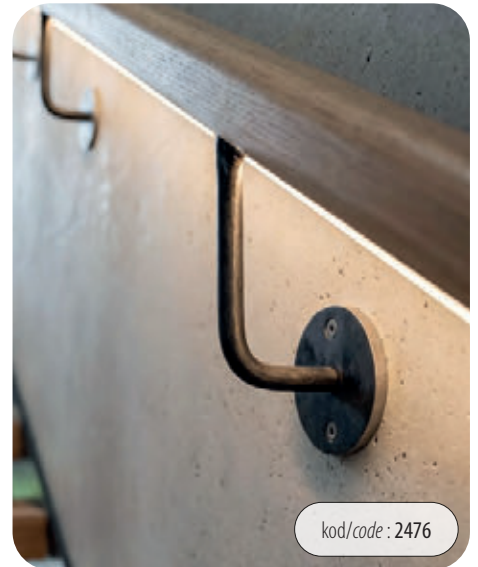

kod/code : 2476

21313
□ 30x10 mm
100x500 mm

21314
□ 30x10 mm
100x150 mm

21316
□ 30x10 mm
170x320 mm

Flütler - Flute Bars



Kod Code	Ölçü Dimension	Delik Ölçüsü Hole Size	Delikler Arası Pitch
2319	14x14x2000 mm	12x12 mm	125 mm
2320	14x14x2000 mm	12x12 mm	140 mm
2321	14x14x2000 mm	14x14 mm	125 mm
2322	14x14x2000 mm	14x14 mm	140 mm
2323	16x16x2000 mm	14x14 mm	125 mm
2324	16x16x2000 mm	14x14 mm	150 mm
2325	16x16x2000 mm	16x16 mm	125 mm
2326	16x16x2000 mm	16x16 mm	150 mm



Kod Code	Ölçü Dimension	Delik Ölçüsü Hole Size	Delikler Arası Pitch
2327	Ø14x2000 mm	Ø12 mm	125 mm
2328	Ø14x2000 mm	Ø12 mm	140 mm
2329	Ø14x2000 mm	Ø14 mm	125 mm
2330	Ø14x2000 mm	Ø14 mm	140 mm
2331	Ø16x2000 mm	Ø14 mm	125 mm
2332	Ø16x2000 mm	Ø14 mm	150 mm
2333	Ø16x2000 mm	Ø16 mm	125 mm
2334	Ø16x2000 mm	Ø16 mm	150 mm



Kod Code	Ölçü Dimension	Delik Ölçüsü Hole Size	Delikler Arası Pitch
2335	14x14x2000 mm	12x12 mm	125 mm
2336	14x14x2000 mm	12x12 mm	140 mm
2337	14x14x2000 mm	14x14 mm	125 mm
2338	14x14x2000 mm	14x14 mm	140 mm
2339	16x16x2000 mm	14x14 mm	125 mm
2340	16x16x2000 mm	14x14 mm	150 mm
2341	16x16x2000 mm	16x16 mm	125 mm
2342	16x16x2000 mm	16x16 mm	150 mm



Kod Code	Ölçü Dimension	Delik Ölçüsü Hole Size	Delikler Arası Pitch
2343	2x35x1940 mm	15.5x15.5 mm	130 mm

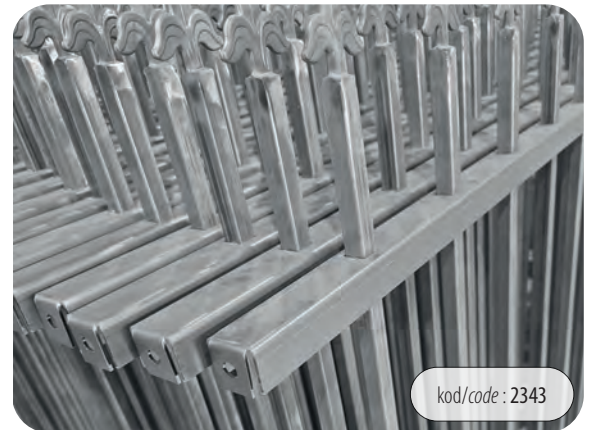

Bağlantı Elemanları - Connection Accessories

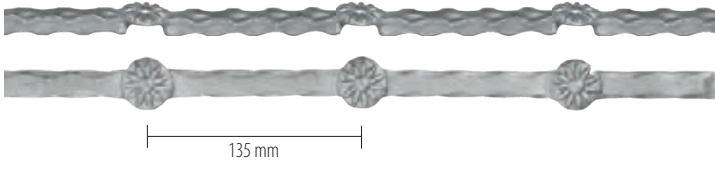

Kod Code	Ölçü Dimension	Delikler Arası Pitch
26106-B	12x12x2000 mm	135 mm
26106	14x14x2000 mm	135 mm
26107	16x16x2000 mm	135 mm



Kod Code	Ölçü Dimension	Delikler Arası Pitch
26106-C	12x12x2000 mm	135 mm
26106-A	14x14x2000 mm	135 mm
26107-A	16x16x2000 mm	135 mm

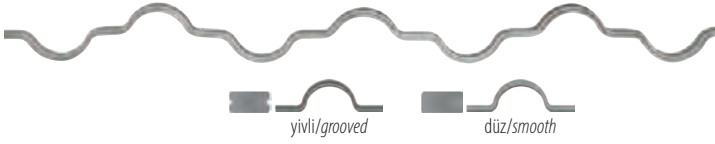

Kod Code	Malzeme Material	Ölçü Dimension	Malzeme Material
26200	12x6 mm	65x2000 mm	yivli (grooved)
26200-A	12x6 mm	65x2000 mm	düz (smooth)
26202	12x12 mm	65x2000 mm	yivli (grooved)
26202-A	12x12 mm	65x2000 mm	düz (smooth)



Kod Code	Malzeme Material	Ölçü Dimension
26300	16x7 mm	135x950 mm



Kod Code	Malzeme Material	Ölçü Dimension
26301	16x7 mm	170x950 mm



Kod Code	Malzeme Material	Ölçü Dimension
26302	16x7 mm	135x950 mm



Kod Code	Malzeme Material	Ölçü Dimension
26303	Ø12 mm	170x970 mm

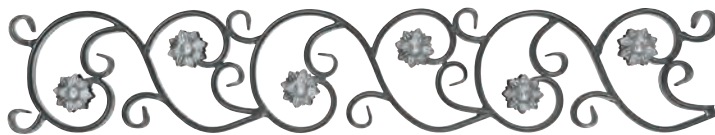

Kod Code	Malzeme Material	Ölçü Dimension
26303-A	16x7 mm	170x970 mm

Döküm Aksesuarlar - Cast Accessories



6000

1340x600 mm
alüminyum döküm
(aluminium cast)
18,10 kg



6013

200x220 mm
alüminyum döküm
(aluminium cast)
5,38 kg

Bank Ayakları- Bench Legs

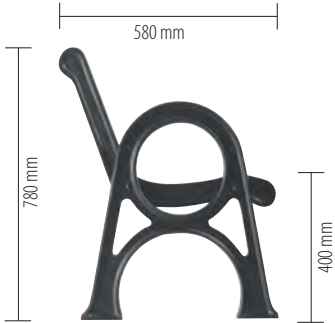

Kod Code	Malzeme Material	Ölçü Dimension
7013	alüminyum döküm (aluminium cast)	580x780x400 mm



Kod Code	Malzeme Material	Ölçü Dimension
7014	alüminyum döküm (aluminium cast)	530x720x380 mm

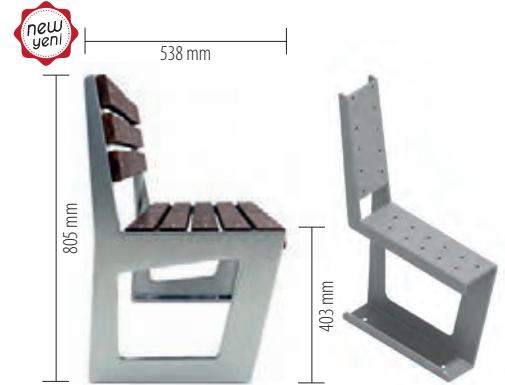

Kod Code	Malzeme Material	Ölçü Dimension
7026	5 mm sac (5 mm metal sheet)	538x805x403 mm



Kod Code	Malzeme Material	Ölçü Dimension
7015	alüminyum döküm (aluminium cast)	450x340 mm



Kod Code	Malzeme Material	Ölçü Dimension
7016	alüminyum döküm (aluminium cast)	530x410 mm



Döküm Masalar ve Sandalyeler - Cast Tables and Chairs



Kod Code	Yükseklik Height	Tabla Ölçüsü Dimension
7304	720 mm	900x900 mm



Kod Code	Yükseklik Height	Tabla Ölçüsü Dimension
7305	740 mm	Ø 900 mm

new
yeni

Kod Code	Yükseklik Height	Tabla Ölçüsü Dimension
7306	700 mm	Ø 800 mm

new
yeni

Kod Code	Yükseklik Height	Tabla Ölçüsü Dimension
7307	730 mm	Ø 1200 mm



Kod Code	Yükseklik Height	Genişlik Width	Derinlik Depth
7400	930 mm	440 mm	410 mm



Kod Code	Yükseklik Height	Genişlik Width	Derinlik Depth
7401	930 mm	440 mm	410 mm



Kod Code	Yükseklik Height	Genişlik Width	Derinlik Depth
7402	870 mm	440 mm	410 mm



Kod Code	Yükseklik Height	Genişlik Width	Derinlik Depth
7403	870 mm	440 mm	420 mm



Kod Code	Yükseklik Height	Genişlik Width	Derinlik Depth
7406	900 mm	570 mm	550 mm

Döküm Çeşmeler - Cast Fountains



7200
450x980 mm
d: 300 mm



7201
350x900 mm
d: 300 mm



7204
440x740 mm
d: 250 mm



7205
520x960 mm
d: 440 mm



7206
440x1000 mm
d: 440 mm



7207
450x840 mm
d: 410 mm

Musluklar - Faucets



7250



7252



7251

Döküm Posta Kutuları - Cast Mail Boxes



7502
250x395 mm
d: 80 mm



7503
240x350 mm
d: 60 mm



7504
230x370 mm
d: 80 mm

Kabartmalı Lazer Kesimli Saclar - Embossed Laser-Cut Sheets



0900
800x1600 mm
1.5 mm



0901
800x1600 mm
1.5 mm



0902
800x1600 mm
1.5 mm



0903
800x1600 mm
1.5 mm



0904
800x1600 mm
1.5 mm

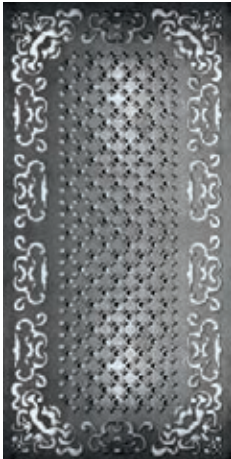

0905
800x1600 mm
1.5 mm

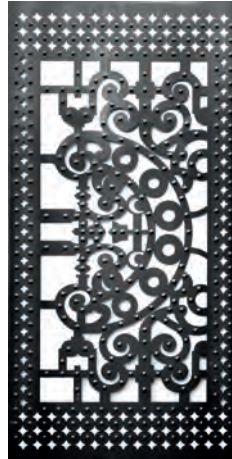

0906
800x1600 mm
1.5 mm



0907
800x1600 mm
1.5 mm

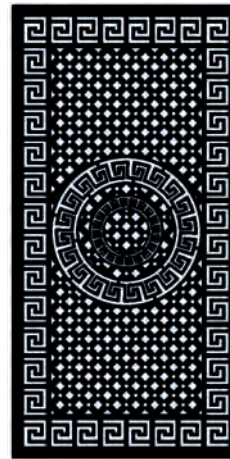

0908
800x1600 mm
1.5 mm

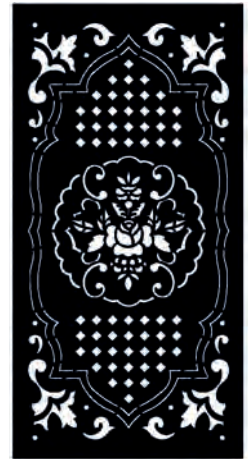

0909
800x1600 mm
1.5 mm

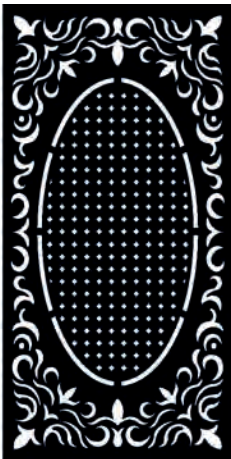

0910
800x1600 mm
1.5 mm

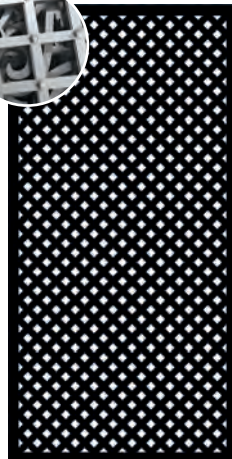

0911
800x1600 mm
1.5 mm



kod/code : 0911



kod/code : 0908

Lazer Kesimli Saclar - Laser-Cut Sheets



1001
1000x2000 mm
3 mm

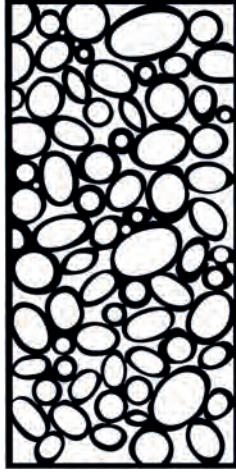

1002
1000x2000 mm
3 mm



1003
1000x2000 mm
3 mm



1005
1000x2000 mm
3 mm



1007
1000x2000 mm
3 mm



1008
1000x2000 mm
3 mm

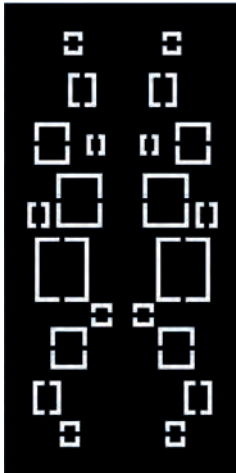

1009
1000x2000 mm
3 mm

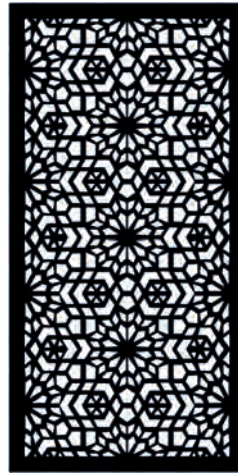

1010
1000x2000 mm
3 mm



1012
1000x2000 mm
3 mm



1013
1000x2000 mm
3 mm



1014
1000x2000 mm
3 mm

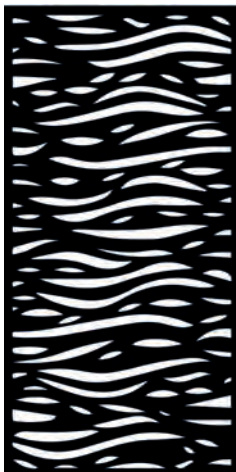

1016
1000x2000 mm
3 mm

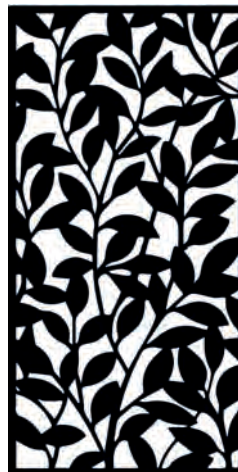

1017
1000x2000 mm
3 mm



1019
1000x2000 mm
3 mm



1020
1000x2000 mm
3 mm

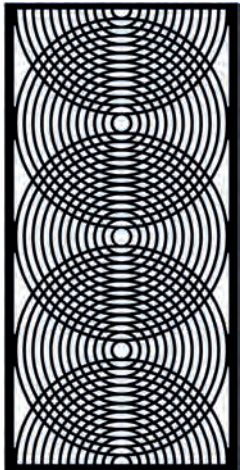

1022
1000x2000 mm
3 mm

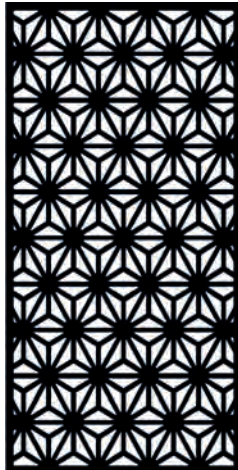

1023
1000x2000 mm
3 mm



1024
1000x2000 mm
3 mm

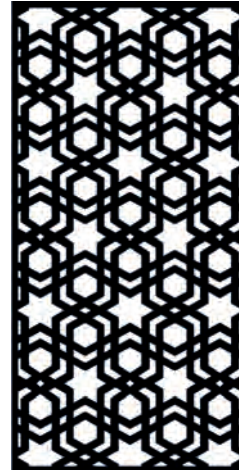

1029
1000x2000 mm
3 mm



1030
1000x2000 mm
3 mm

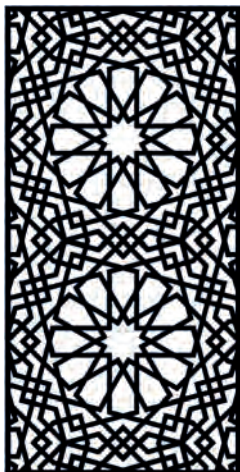

1033
1000x2000 mm
3 mm



1036
1000x2000 mm
3 mm



1040
1000x2000 mm
3 mm

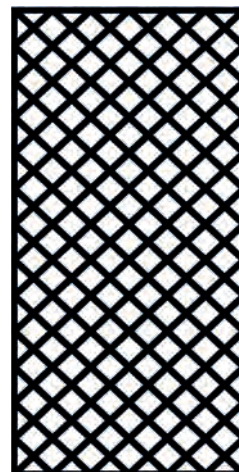

1046
1000x2000 mm
3 mm



1049
1000x2000 mm
3 mm



1050
1000x2000 mm
3 mm



1054
1000x2000 mm
3 mm



1060
1000x2000 mm
3 mm

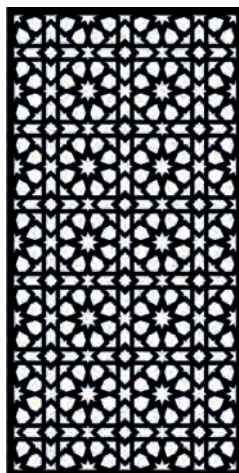

1061
1000x2000 mm
3 mm

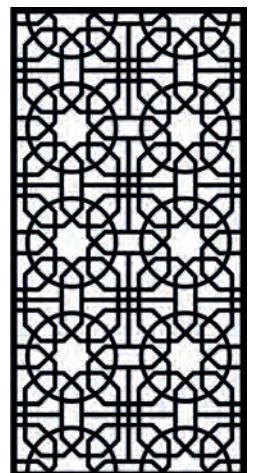

1062
1000x2000 mm
3 mm

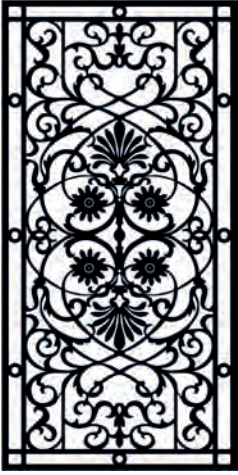

1063
1000x2000 mm
3 mm

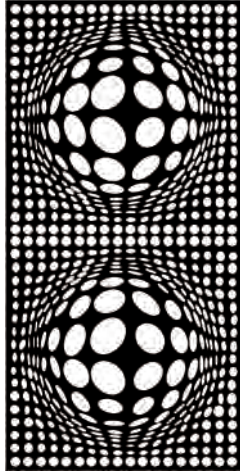

1065
1000x2000 mm
3 mm



1066
1000x2000 mm
3 mm



1067
1000x2000 mm
3 mm



1068
1000x2000 mm
3 mm

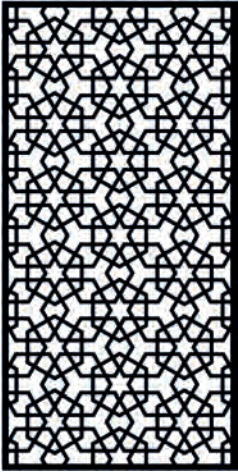

1070
1000x2000 mm
3 mm



1072
1000x2000 mm
3 mm

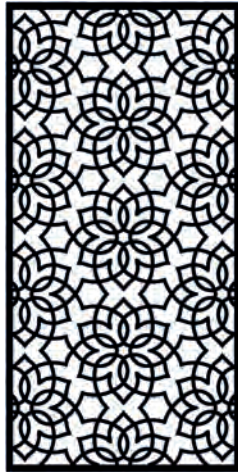

1073
1000x2000 mm
3 mm



1078
1000x2000 mm
3 mm



1079
1000x2000 mm
3 mm



1079-A
2000x1000 mm
3 mm



1083
1000x2000 mm
3 mm



1084
1000x2000 mm
3 mm



1086
1000x2000 mm
3 mm



1088
1000x2000 mm
3 mm

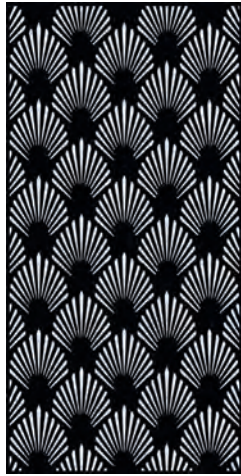

1089
1000x2000 mm
3 mm

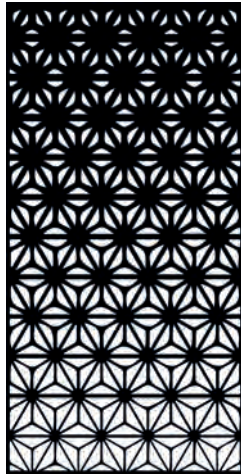

1090
1000x2000 mm
3 mm

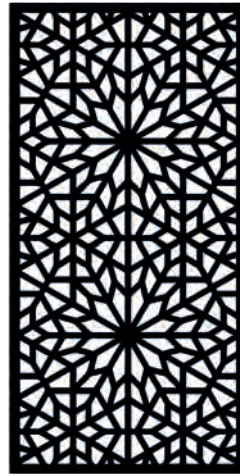

1094
1000x2000 mm
3 mm

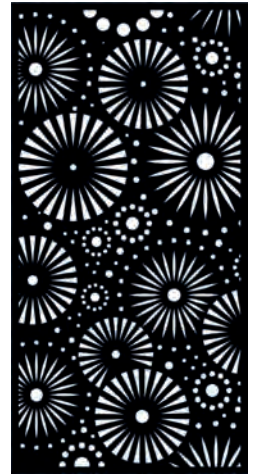

1095
1000x2000 mm
3 mm



1097
1000x2000 mm
3 mm



1099
1000x2000 mm
3 mm



1100
1000x2000 mm
3 mm



1101
1000x2000 mm
3 mm



1104
1000x2000 mm
3 mm



1106
1000x2000 mm
3 mm



1107
1000x2000 mm
3 mm



1109
1000x2000 mm
3 mm



1110
1000x2000 mm
3 mm



1120
1000x2000 mm
3 mm



1121
1000x2000 mm
3 mm



1122
1000x2000 mm
3 mm



1125
1000x2000 mm
3 mm



1128
1000x2000 mm
3 mm

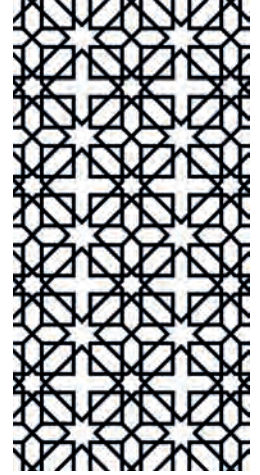

1142
1000x2000 mm
3 mm



1144
1000x2000 mm
3 mm

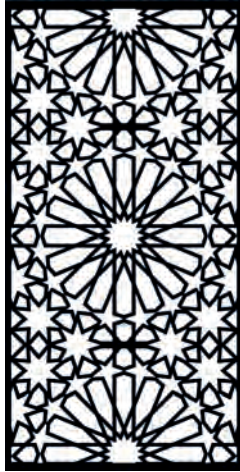

1147
1000x2000 mm
3 mm

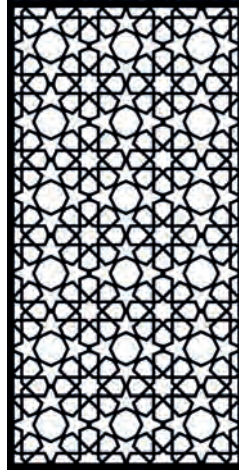

1157
1000x2000 mm
3 mm

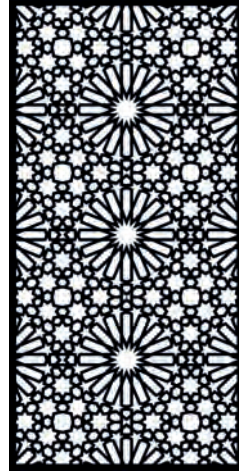

1158
1000x2000 mm
3 mm

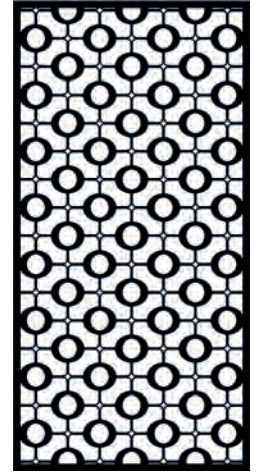

1159
1000x2000 mm
3 mm



1160
1000x2000 mm
3 mm



1161
1000x2000 mm
3 mm



1162
1000x2000 mm
3 mm

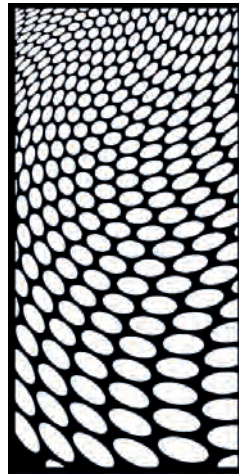

1165
1000x2000 mm
3 mm



1170
1000x2000 mm
3 mm

İstenilen ölçüye üretilir / requested size can be produced

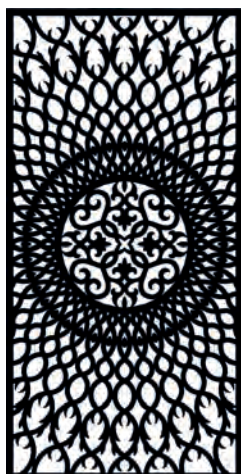

1171
1000x2000 mm
3 mm



1175
1000x2000 mm
3 mm



1188
1000x2000 mm
3 mm



1190
1000x2000 mm
3 mm



1195
1000x2000 mm
3 mm



1197
1000x2000 mm
3 mm

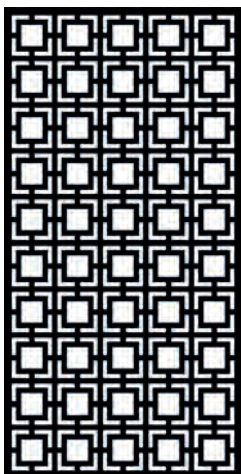

1200
1000x2000 mm
3 mm



1201
1000x2000 mm
3 mm

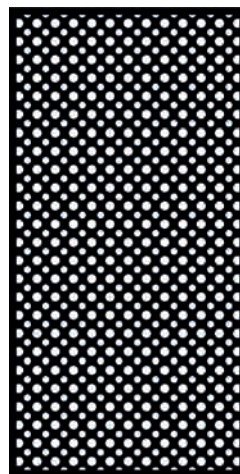

1206
1000x2000 mm
3 mm

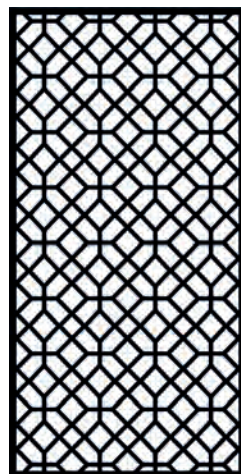

1207
1000x2000 mm
3 mm



1213
1000x2000 mm
3 mm



1223
1000x2000 mm
3 mm



1224
1000x2000 mm
3 mm



1225
500x2000 mm
3 mm



1226
1000x2000 mm
3 mm



1229
1000x2000 mm
3 mm

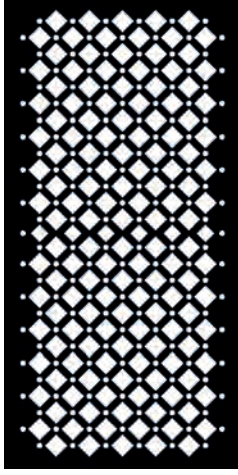

1235
1000x2000 mm
3 mm



1238
1000x2000 mm
3 mm



1241
1000x2000 mm
3 mm



1250
1000x2000 mm
3 mm

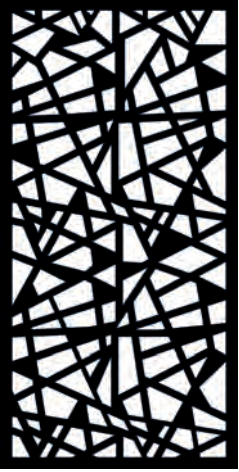

1252
1000x2000 mm
3 mm

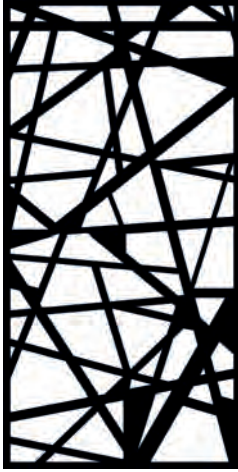

1253
1000x2000 mm
3 mm

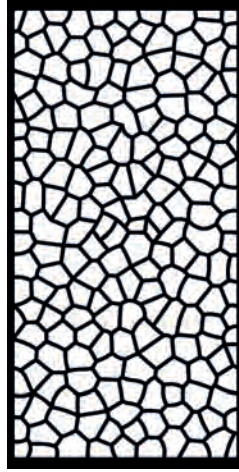

1254
1000x2000 mm
3 mm

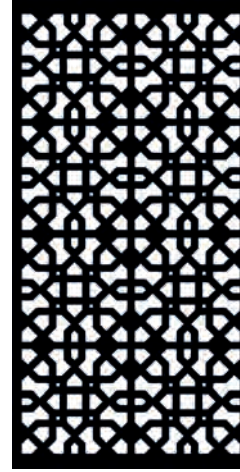

1255
1000x2000 mm
3 mm

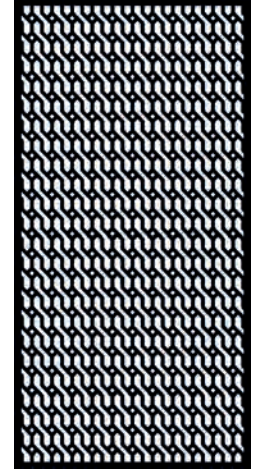

1256
1000x2000 mm
3 mm

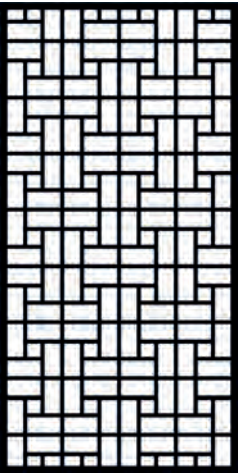

1257
1000x2000 mm
3 mm

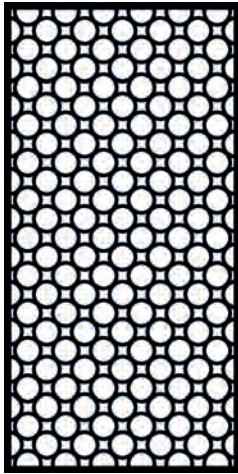

1258
1000x2000 mm
3 mm

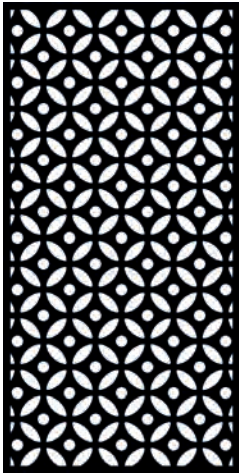

1261
1000x2000 mm
3 mm



1264
1000x2000 mm
3 mm



1271
1000x2000 mm
3 mm



1266
1000x2000 mm
3 mm



1267
500x2000 mm
3 mm



1272
1000x2000 mm
3 mm



1273
1000x2000 mm
3 mm

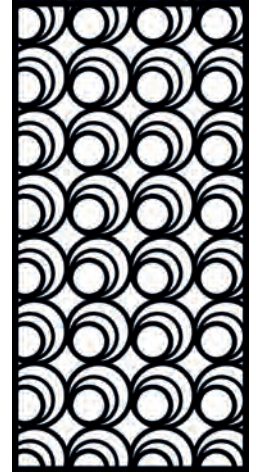

1276
1000x2000 mm
3 mm

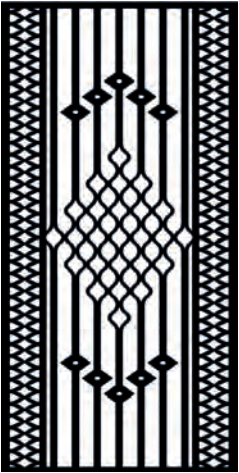

1278
1000x2000 mm
3 mm

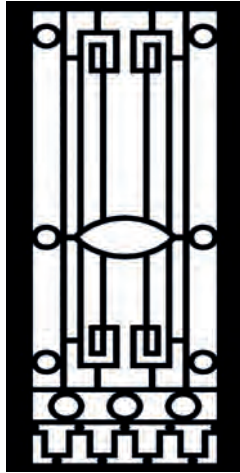

1279
1000x2000 mm
3 mm



1288
1000x2000 mm
3 mm

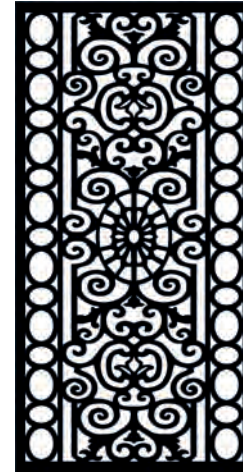

1289
100x2000 mm
3 mm



1292
1000x2000 mm
3 mm



1295
1000x2000 mm
3 mm



1296
1000x2000 mm
3 mm



1297
500x2000 mm
3 mm

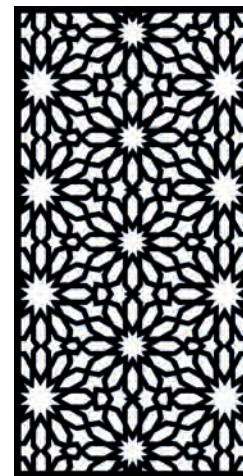

1298
1000x2000 mm
3 mm

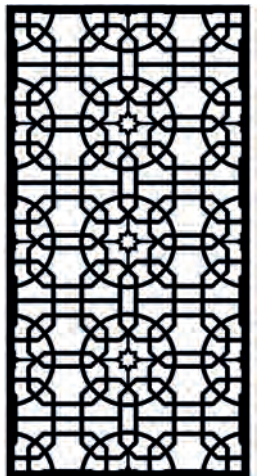

1301
1000x2000 mm
3 mm



1308
1000x2000 mm
3 mm



1314
1000x2000 mm
3 mm

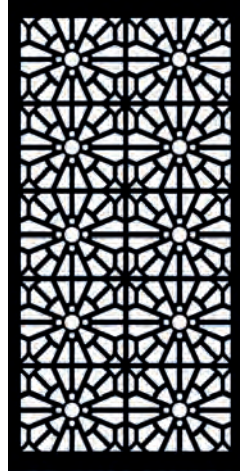

1319
1000x2000 mm
3 mm

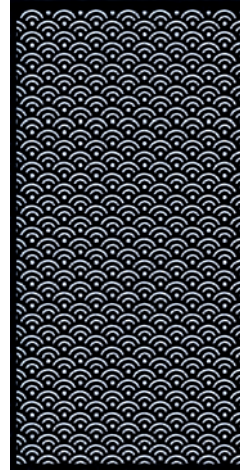

1331
1000x2000 mm
3 mm



1337
1000x2000 mm
3 mm



1339
1000x2000 mm
3 mm



1343
1000x2000 mm
3 mm

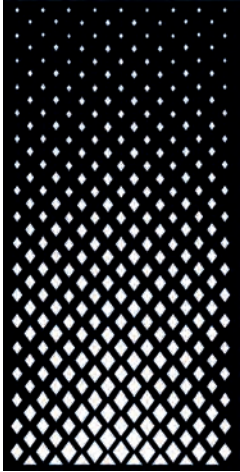

1345
1000x2000 mm
3 mm



1346
1000x2000 mm
3 mm

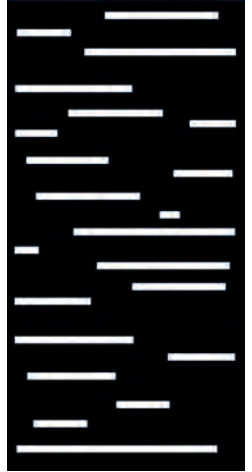

1347
1000x2000 mm
3 mm



1348
1000x2000 mm
3 mm

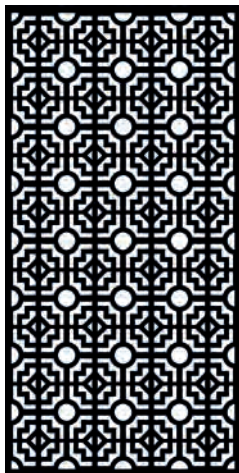

1351
1000x2000 mm
3 mm



1352
1000x2000 mm
3 mm

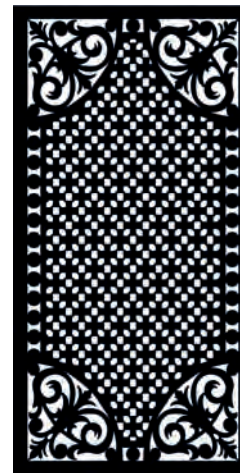

1353
1000x2000 mm
3 mm

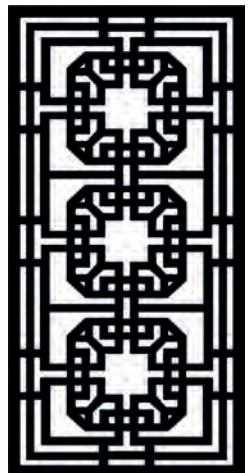

1355
1000x2000 mm
3 mm

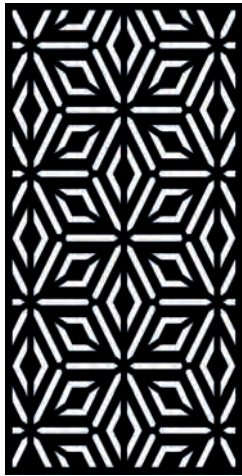

1356
1000x2000 mm
3 mm



1370
1000x2000 mm
3 mm

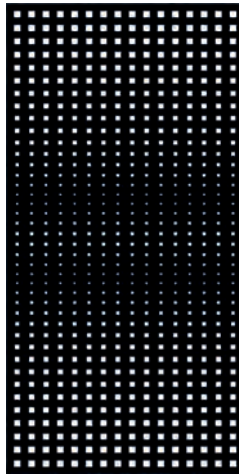

1381
1000x2000 mm
3 mm



1382
1000x2000 mm
3 mm



1383
1000x2000 mm
3 mm

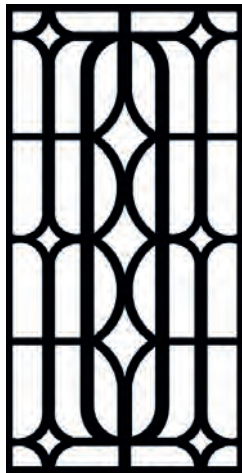

1384
1000x2000 mm
3 mm

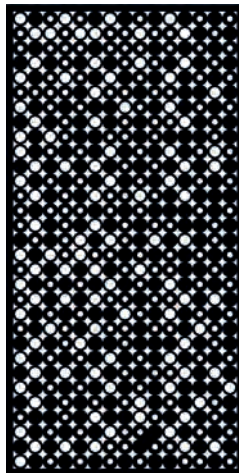

1388
1000x2000 mm
3 mm



1393
1000x2000 mm
3 mm

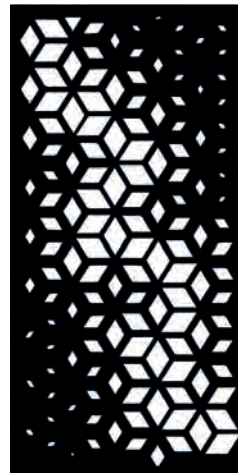

1394
1000x2000 mm
3 mm



1395
1000x2000 mm
3 mm

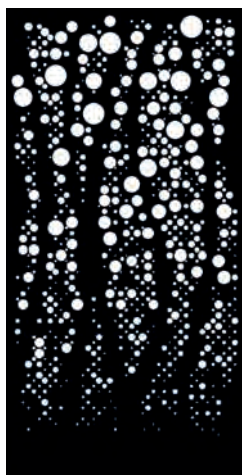

1454
1000x2000 mm
3 mm

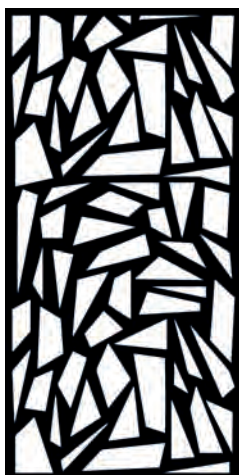

1456
1000x2000 mm
3 mm

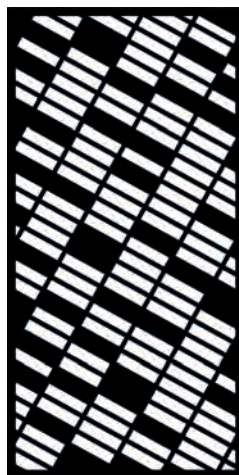

1460
1000x2000 mm
3 mm

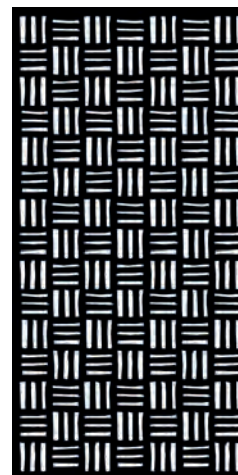

1464
1000x2000 mm
3 mm

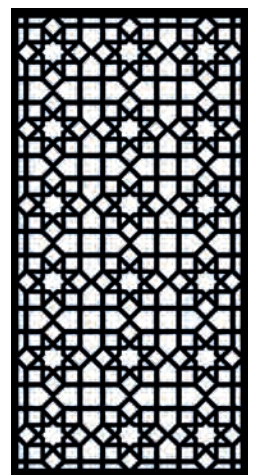

1471
1000x2000 mm
3 mm

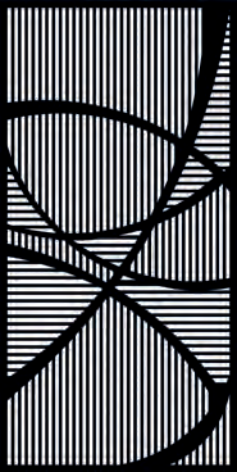

1472
1000x2000 mm
3 mm



1473
1000x2000 mm
3 mm

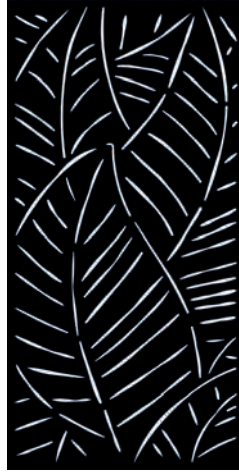

1475
1000x2000 mm
3 mm

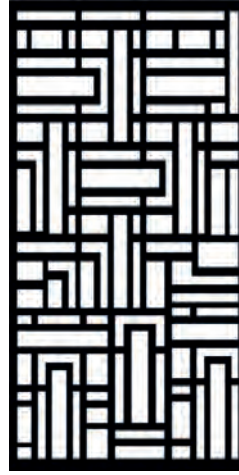

1480
1000x2000 mm
3 mm

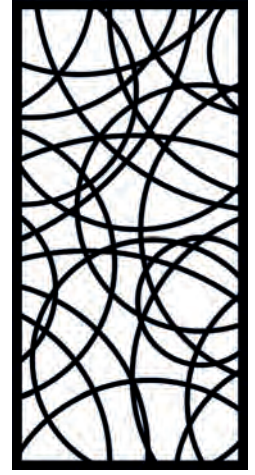

1482
1000x2000 mm
3 mm



1492
1000x2000 mm
3 mm

new
yeni



1495
1000x2000 mm
3 mm

new
yeni

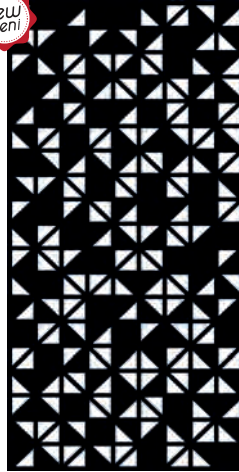

1497
1000x2000 mm
3 mm



1499
1000x2000 mm
3 mm

new
yeni



1650
1000x2000 mm
3 mm

new
yeni



1651
1000x2000 mm
3 mm

new
yeni

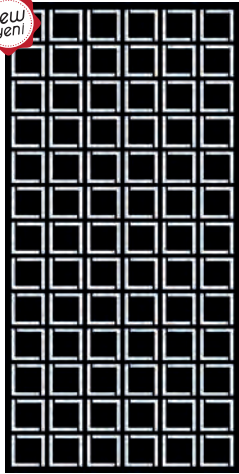

1652
1000x2000 mm
3 mm

new
yeni



1653
1000x2000 mm
3 mm

new
yeni

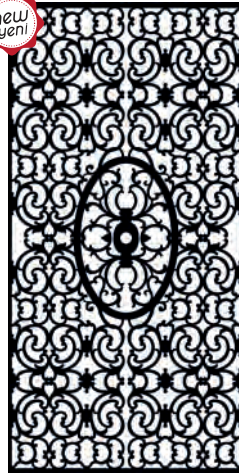

1654
1000x2000 mm
3 mm

new
yeni

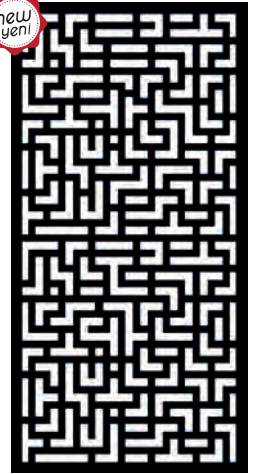

1655
1000x2000 mm
3 mm

istemen ölçülerde üretilebilir / requested size can be produced



1754
2000x1000 mm
3 mm



1756
2000x1000 mm
3 mm

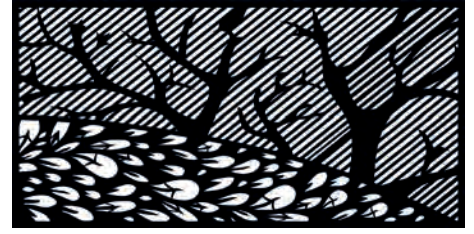

1760
2000x1000 mm
3 mm



1761
2000x1000 mm
3 mm



1762
2000x1000 mm
3 mm



1763
2000x1000 mm
3 mm



1764
2000x1000 mm
3 mm

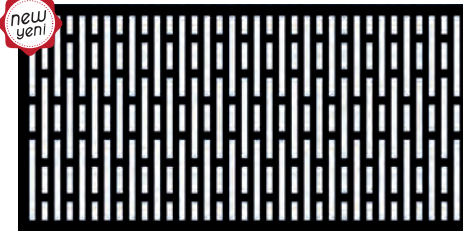

1765
2000x1000 mm
3 mm

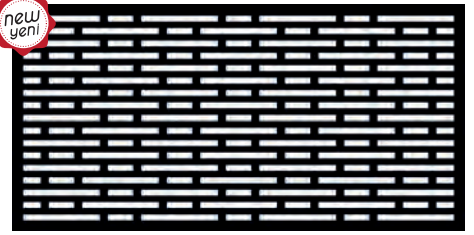

1766
2000x1000 mm
3 mm



1426
1000x1000 mm
3 mm

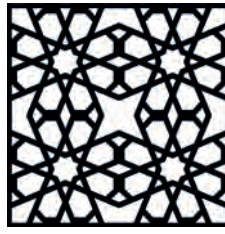

1427
1000x1000 mm
3 mm

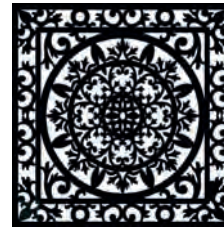

1430
1000x1000 mm
3 mm



1432
1000x1000 mm
3 mm



1433
1000x1000 mm
3 mm



1434
1000x1000 mm
3 mm

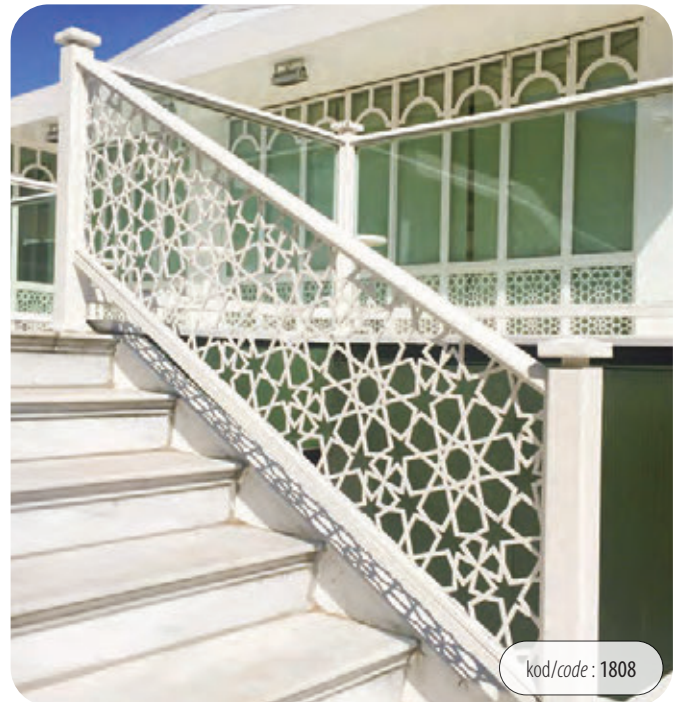

kod/code : 1808

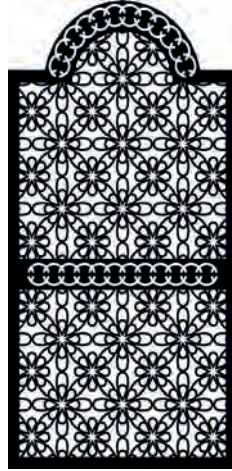

1700
1000x2350 mm
3 mm

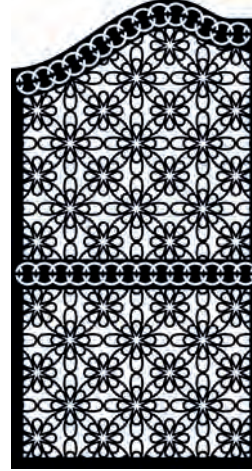

1701
1248x2350 mm
3 mm

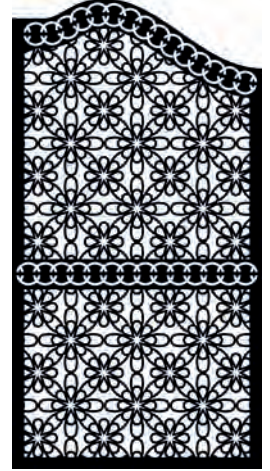

1702
1248x2350 mm
3 mm



1709
1000x2350 mm
3 mm



1710
1248x2350 mm
3 mm

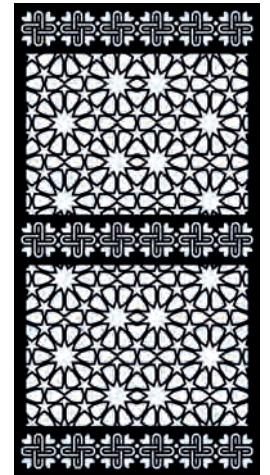

1711
1248x2350 mm
3 mm



1715
1000x2350 mm
3 mm



1716
1248x2350 mm
3 mm

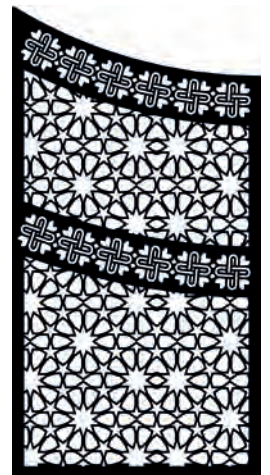

1717
1248x2350 mm
3 mm

Lazer Kesimli Sac Bordürler - Laser-Cut Frames



1500
100x1000 mm
3 mm



1500-A
120x1000 mm
3 mm



1501
100x1000 mm
3 mm



1501-A
120x1000 mm
3 mm



1502
120x1000 mm
3 mm



1503
120x1000 mm
3 mm

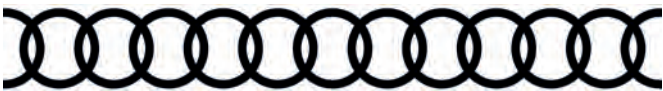

1504
120x1000 mm
3 mm



1504-A
100x1000 mm
3 mm



1505
120x1000 mm
3 mm



1506
95x1000 mm
3 mm



1507
120x1000 mm
3 mm

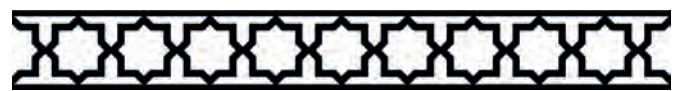

1508
120x1000 mm
3 mm



1509
100x1000 mm
3 mm



1510
100x1000 mm
3 mm



1511
120x1000 mm
3 mm



1512
120x1000 mm
3 mm



1513
120x1000 mm
3 mm



1514
120x1000 mm
3 mm

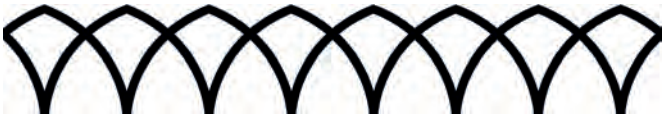

1515
165x1000 mm
3 mm



1516
165x1000 mm
3 mm



1517
100x1000 mm
3 mm



1518
100x1000 mm
3 mm



1519
100x1000 mm
3 mm



1520
120x1000 mm
3 mm



1521
100x1000 mm
3 mm



1522
100x1000 mm
3 mm



1523
120x1000 mm
3 mm



1524
96x976mm
3 mm



1525
75x1000 mm
3 mm



1525-A
120x1000 mm
3 mm



1526
100x1000 mm
3 mm



1527
120x1000 mm
3 mm



1529
100x1000 mm
3 mm



1530
120x1000 mm
3 mm



1531
120x1000 mm
3 mm



1537
120x1000 mm
3 mm



1541
90x1000 mm
3 mm



1542
190x1000 mm
3 mm

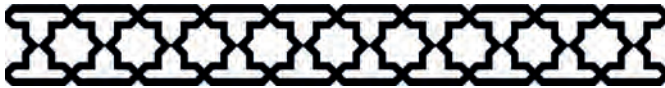

1544
120x1000 mm
3 mm



1547
120x1000 mm
3 mm



1548
120x1000 mm
3 mm



1549
190x1130 mm
6 mm

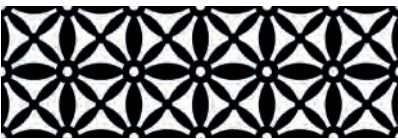

1802
1200x400 mm
3 mm



1804
1200x400 mm
3 mm

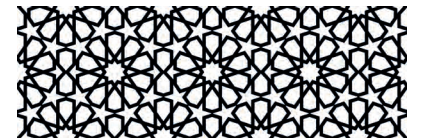

1808
1200x400 mm
3 mm

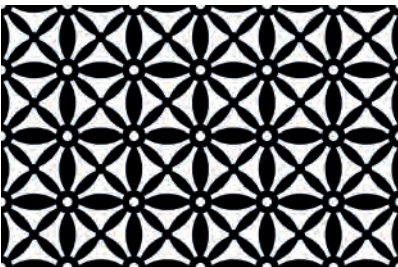

1803
1200x800 mm
3 mm

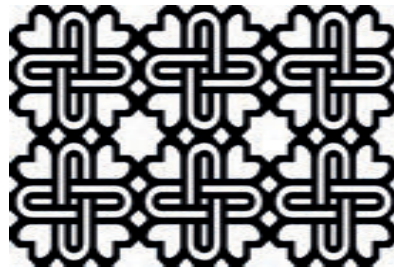

1805
1200x800 mm
3 mm

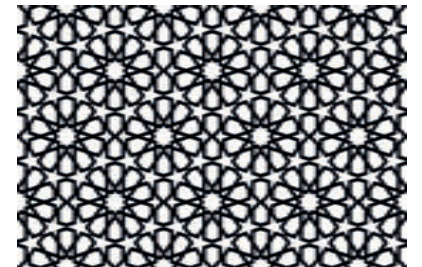

1809
1200x800 mm
3 mm

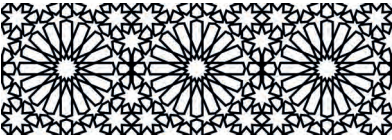

1810
1200x400 mm
3 mm

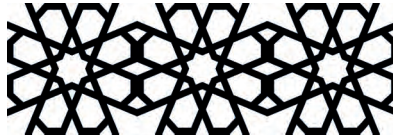

1812
1200x400 mm
3 mm

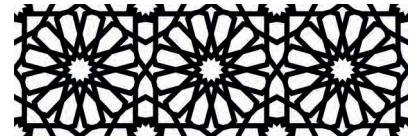

1814
1200x400 mm
3 mm

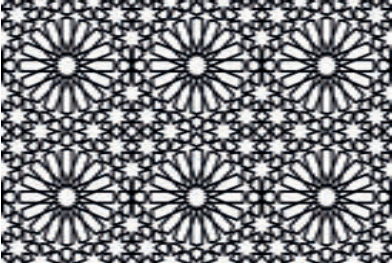

1811
1200x800 mm
3 mm

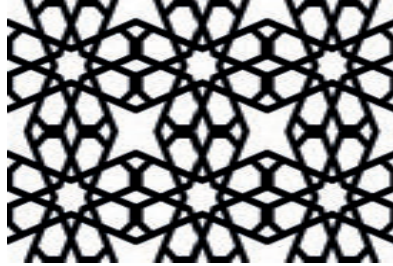

1813
1200x800 mm
3 mm

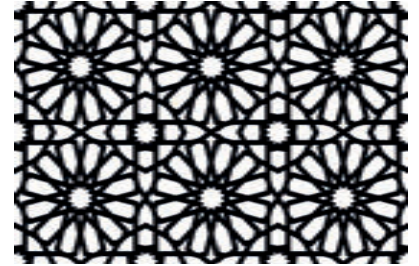

1815
1200x800 mm
3 mm

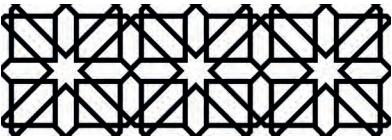

1816
1200x400 mm
3 mm



1820
1200x400 mm
3 mm

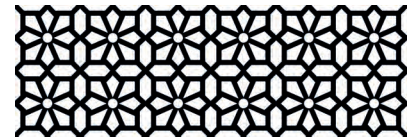

1822
1200x400 mm
3 mm

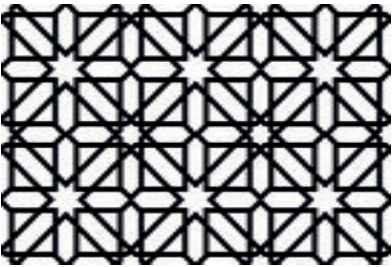

1817
1200x800 mm
3 mm

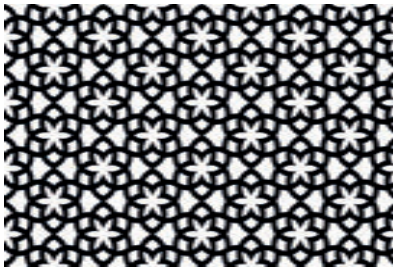

1821
1200x800 mm
3 mm

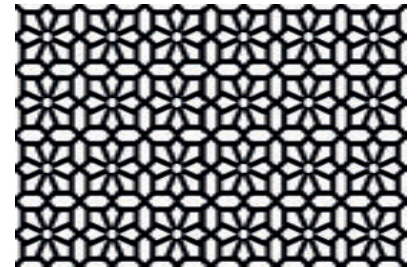

1823
1200x800 mm
3 mm

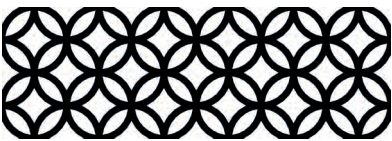

1826
1200x400 mm
3 mm

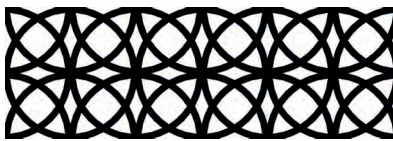

1828
1200x400 mm
3 mm



1827
1200x800 mm
3 mm

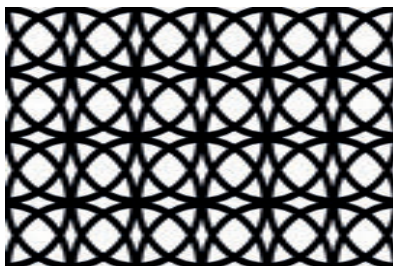

1829
1200x800 mm
3 mm



kod/code : 1814



1900

230x900 mm
4 mm



1903

250x900 mm
4 mm



1904

240x900 mm
4 mm



1906

240x900 mm
4 mm



1907

240x900 mm
4 mm



1914

240x900 mm
4 mm



1916

250x900 mm
4 mm



1918

250x900 mm
4 mm



1919

250x900 mm
4 mm



1933

260x800 mm
3 mm



kod/code : 1812



1934

220x800 mm
3 mm

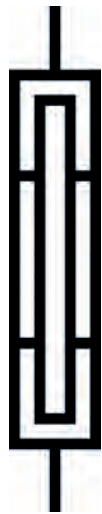

1974

180x1000 mm
4 mm



1989

140x900 mm
4 mm



kod/code : 1934



1925
Ø 500 mm
3 mm



1925-A
Ø 500 mm
3 mm



1926
Ø 500 mm
3 mm



1926-A
Ø 500 mm
3 mm



1927
Ø 500 mm
3 mm



1932
Ø 500 mm
3 mm



1936
Ø 500 mm
3 mm



1938
Ø 500 mm
3 mm



1947
Ø 500 mm
3 mm

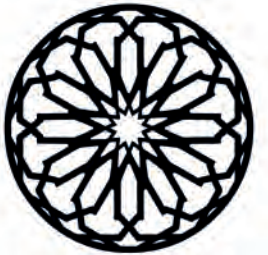

1975
Ø 500 mm
3 mm



1976
Ø 500 mm
3 mm

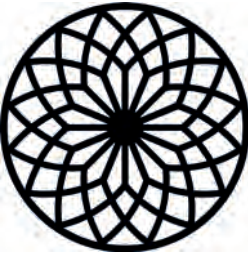

1977
Ø 500 mm
3 mm

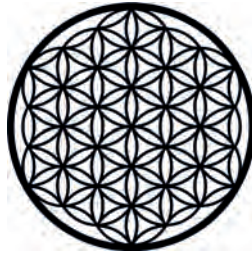

8022
Ø 500 mm
3 mm



kod/code : 1925



1980
400x400 mm
3 mm



1982
400x400 mm
3 mm



8080
400x400 mm
3 mm



8081
400x400 mm
3 mm



1935
700x300 mm
3 mm



1950
350x430 mm
6 mm



1952
350x430 mm
6 mm



1953
160x435 mm
6 mm



1954
160x376 mm
6 mm



1955
160x288 mm
6 mm



1956
160x323 mm
6 mm



1957
160x435 mm
6 mm



1958
350x430 mm
6 mm



1959
350x430 mm
6 mm



1960
350x430 mm
6 mm



1961
350x430 mm
6 mm



1962
315x480 mm
6 mm



1963
415x520 mm
6 mm



1964
315x400 mm
6 mm



1965
350x500 mm
6 mm



1966
350x400 mm
6 mm

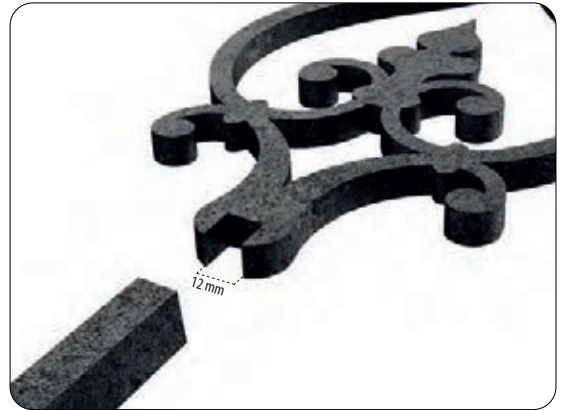

kod/code : 1952



Kod Code	Sayfa Page	Kod Code	Sayfa Page	Kod Code	Sayfa Page	Kod Code	Sayfa Page	Kod Code	Sayfa Page
0400	31	0440	41	0479	52	0504	32	0524	37
0401	31	0441	41	0479-A	52	0504-A	32	0524-A	37
0402	31	0442	41	0480	52	0505	32	0525	37
0403	31	0443	41	0480-A	52	0505-A	32	0525-A	37
0404	32	0444	42	0481	52	0506	32	0526	37
0405	32	0445	42	0481-A	52	0506-A	32	0526-A	37
0406	32	0446	42	0482	52	0507	32	0527	37
0407	32	0447	42	0482-A	52	0507-A	32	0527-A	37
0408	33	0448	43	0483	52	0508	33	0528	38
0409	33	0449	43	0483-A	52	0508-A	33	0528-A	38
0410	33	0450	43	0484	53	0509	33	0529	38
0411	33	0451	43	0484-A	53	0509-A	33	0529-A	38
0412	34	0452	44	0485	53	0510	33	0530	38
0413	34	0453	44	0485-A	53	0510-A	33	0530-A	38
0414	34	0454	44	0486	53	0511	33	0531	38
0415	34	0455	44	0486-A	53	0511-A	33	0531-A	38
0416	35	0456	45	0487	53	0512	34	0532	39
0417	35	0457	45	0487-A	53	0512-A	34	0532-A	39
0418	35	0458	45	0488	53	0513	34	0533	39
0419	35	0459	45	0488-A	53	0513-A	34	0533-A	39
0420	36	0460	46	0489	53	0514	34	0534	39
0421	36	0461	46	0489-A	53	0514-A	34	0534-A	39
0422	36	0462	46	0490-A	54	0515	34	0535	39
0423	36	0463	46	0491-A	54	0515-A	34	0535-A	39
0424	37	0464	47	0492-A	54	0516	35	0536	40
0425	37	0465	47	0493-A	54	0516-A	35	0536-A	40
0426	37	0466	47	0494-A	54	0517	35	0537	40
0427	37	0467	47	0495-A	54	0517-A	35	0537-A	40
0428	38	0468	48	0496-A	54	0518	35	0538	40
0429	38	0469	48	0497-A	54	0518-A	35	0538-A	40
0430	38	0470	48	0498-A	54	0519	35	0539	40
0431	38	0471	48	0499-A	54	0519-A	35	0539-A	40
0432	39	0472	49	0500	31	0520	36	0540	41
0433	39	0473	49	0500-A	31	0520-A	36	0540-A	41
0434	39	0474	49	0501	31	0521	36	0541	41
0435	39	0475	49	0501-A	31	0521-A	36	0541-A	41
0436	40	0476	50	0502	31	0522	36	0542	41
0437	40	0477	50	0502-A	31	0522-A	36	0542-A	41
0438	40	0478	52	0503	31	0523	36	0543	41
0439	40	0478-A	52	0503-A	31	0523-A	36	0543-A	41

Kod Code	Sayfa Page	Kod Code	Sayfa Page	Kod Code	Sayfa Page	Kod Code	Sayfa Page	Kod Code	Sayfa Page
0544	42	0564	47	0611	29	0782	26	1024	127
0544-A	42	0564-A	47	0612	29	0783	26	1029	127
0545	42	0565	47	0613	29	0784	26	1030	127
0545-A	42	0565-A	47	0614	29	0785	26	1033	127
0546	42	0566	47	0615	29	0786	26	1036	127
0546-A	42	0566-A	47	0616	29	0787	26	1040	127
0547	42	0567	47	0617	29	0788	26	1046	127
0547-A	42	0567-A	47	0618	29	0789	26	1049	127
0548	43	0568	48	0619	29	0790	27	1050	127
0548-A	43	0568-A	48	0620	29	0791	27	1054	127
0549	43	0569	48	0621	29	0793	27	1060	127
0549-A	43	0569-A	48	0622	29	0900	125	1061	127
0550	43	0570	48	0623	30	0901	125	1062	127
0550-A	43	0570-A	48	0624	30	0902	125	1063	128
0551	43	0571	48	0625	30	0903	125	1065	128
0551-A	43	0571-A	48	0626	30	0904	125	1066	128
0552	44	0572	49	0700-10/5	24	0905	125	1067	128
0552-A	44	0572-A	49	0701-13/7	24	0906	125	1068	128
0553	44	0573	49	0702-25/8	24	0907	125	1070	128
0553-A	44	0573-A	49	0702-A-20/8	24	0908	125	1072	128
0554	44	0574	49	0703-30/13	24	0909	125	1073	128
0554-A	44	0574-A	49	0704-42/14	24	0910	125	1078	128
0555	44	0575	49	0704-A-40/20	24	0911	125	1079	128
0555-A	44	0575-A	49	0705-50/18	24	1001	126	1079-A	128
0556	45	0576	50	0706-62/24	25	1002	126	1083	128
0556-A	45	0576-A	50	0708-76/31	25	1003	126	1084	128
0557	45	0577	50	0709-94/38	25	1005	126	1086	128
0557-A	45	0577-A	50	0710-110/45	25	1007	126	1088	129
0558	45	0600	28	0710-A-100/50	25	1008	126	1089	129
0558-A	45	0601	28	0771	26	1009	126	1090	129
0559	45	0601-A	28	0772	26	1010	126	1094	129
0559-A	45	0602	28	0772-A	26	1012	126	1095	129
0560	46	0603	28	0773	26	1013	126	1097	129
0560-A	46	0604	28	0773-A	26	1014	126	1099	129
0561	46	0605	28	0774	26	1016	126	1100	129
0561-A	46	0606	28	0775	26	1017	126	1101	129
0562	46	0607	28	0776	26	1019	126	1104	129
0562-A	46	0608	28	0777	26	1020	126	1106	129
0563	46	0609	28	0780	26	1022	127	1107	129
0563-A	46	0610	28	0781	26	1023	127	1109	129

Kod Code	Sayfa Page	Kod Code	Sayfa Page	Kod Code	Sayfa Page	Kod Code	Sayfa Page	Kod Code	Sayfa Page
1110	129	1255	132	1382	135	1510	139	1711	138
1120	129	1256	132	1383	135	1511	139	1715	138
1121	130	1257	132	1384	135	1512	139	1716	138
1122	130	1258	132	1388	135	1513	140	1717	138
1125	130	1261	132	1393	135	1514	140	1754	137
1128	130	1264	132	1394	135	1515	140	1756	137
1142	130	1266	133	1395	135	1516	140	1760	137
1144	130	1267	133	1426	137	1517	140	1761	137
1147	130	1271	132	1427	137	1518	140	1762	137
1157	130	1272	133	1430	137	1519	140	1763	137
1158	130	1273	133	1432	137	1520	140	1764	137
1159	130	1276	133	1433	137	1521	140	1765	137
1160	130	1278	133	1434	137	1522	140	1766	137
1161	130	1279	133	1454	135	1523	140	1802	141
1162	130	1288	133	1456	135	1524	140	1803	141
1165	130	1289	133	1460	135	1525	140	1804	141
1170	130	1292	133	1464	135	1525-A	140	1805	141
1171	131	1295	133	1471	135	1526	140	1808	142
1175	131	1296	133	1472	136	1527	140	1809	142
1188	131	1297	133	1473	136	1529	141	1810	142
1190	131	1298	133	1475	136	1530	141	1811	142
1195	131	1301	133	1480	136	1531	141	1812	142
1197	131	1308	134	1482	136	1537	141	1813	142
1200	131	1314	134	1492	136	1541	141	1814	142
1201	131	1319	134	1495	136	1542	141	1815	142
1206	131	1331	134	1497	136	1544	141	1816	142
1207	131	1337	134	1499	136	1547	141	1817	142
1213	131	1339	134	1500	139	1548	141	1820	142
1223	131	1343	134	1500-A	139	1549	141	1821	142
1224	131	1345	134	1501	139	1650	136	1822	142
1225	131	1346	134	1501-A	139	1651	136	1823	142
1226	131	1347	134	1502	139	1652	136	1826	142
1229	132	1348	134	1503	139	1653	136	1827	142
1235	132	1351	134	1504	139	1654	136	1828	142
1238	132	1352	134	1504-A	139	1655	136	1829	142
1241	132	1353	134	1505	139	1700	138	1900	143
1250	132	1355	134	1506	139	1701	138	1903	143
1252	132	1356	135	1507	139	1702	138	1904	143
1253	132	1370	135	1508	139	1709	138	1906	143
1254	132	1381	135	1509	139	1710	138	1907	143

Kod Code	Sayfa Page	Kod Code	Sayfa Page	Kod Code	Sayfa Page	Kod Code	Sayfa Page	Kod Code	Sayfa Page
1914	143	2002	59	2040	63	2212	57	2248	57
1916	143	2003	59	2041	63	2213	57	2248-A	57
1918	143	2004	59	2042	63	2214	57	2249	57
1919	143	2005	59	2043	63	2217	56	2250	57
1925	144	2006	59	2044	61	2218	56	2252	57
1925-A	144	2007	59	2045	61	2219	56	2253	57
1926	144	2009	59	2050	64	2220	56	2254	58
1926-A	144	2010	59	2050-A	64	2221	56	2255	58
1927	144	2011	59	2051	64	2222	56	2256	58
1932	144	2013	59	2051-A	64	2223	56	2257	58
1933	143	2014	59	2052	64	2229	56	2258	58
1934	143	2015	59	2052-A	64	2231	56	2259	58
1935	143	2016	60	2053	64	2232	56	2260	57
1936	144	2017	60	2053-A	64	2233	57	2260-A	57
1938	144	2018	60	2054	64	2234	57	2260-B	57
1947	144	2019	60	2054-A	64	2234-A	57	2261	57
1950	145	2020	60	2055	64	2235	57	2261-A	57
1952	145	2021	60	2055-A	64	2235-A	57	2261-B	57
1953	145	2022	60	2060	62	2236	57	2261-C	57
1954	145	2023	60	2061	62	2236-A	57	2261-D	57
1955	145	2024	60	2062	62	2237	57	2261-E	57
1956	145	2025	60	2063	62	2237-A	57	2262	58
1957	145	2026	60	2064	62	2238	57	2263	58
1958	145	2027	60	2065	62	2238-A	57	2264	58
1959	145	2028	61	2066	62	2239	57	2265	58
1960	145	2029	61	2067	62	2239-A	57	2266	58
1961	145	2029-A	61	2068	62	2240	57	2267	58
1962	145	2029-B	61	2069	62	2240	58	2268	56
1963	145	2030	61	2070	62	2240-A	58	2269	56
1964	145	2031	61	2071	62	2240-B	58	2271	56
1965	145	2032	61	2072	62	2241	58	2272	56
1966	145	2032-A	61	2200-A	57	2241-A	58	2273	56
1974	143	2032-B	61	2200-B	57	2242	58	2274	56
1975	144	2033	61	2201	56	2243	58	2275	56
1976	144	2034	63	2202	56	2243-A	58	2276	56
1977	144	2035	63	2203	56	2244	58	2277	56
1980	144	2036	63	2211	57	2245	58	2278	56
1982	144	2037	63	2211-A	57	2246-A	57	2279	56
1989	143	2038	63	2211-B	57	2247	57	2280	56
2001	59	2039	63	2211-C	57	2247-A	57	2281	56

Kod Code	Sayfa Page	Kod Code	Sayfa Page	Kod Code	Sayfa Page	Kod Code	Sayfa Page	Kod Code	Sayfa Page
2282	56	2342	120	2391-A	57	2440	109	2501	65
2283	56	2343	120	2392	57	2441	109	2503	65
2284	57	2350	107	2393	57	2442	109	2504	65
2287	57	2351	107	2394	108	2443	109	2505	65
2288	57	2352	107	2395	108	2444	109	2506	65
2289	57	2353	107	2396	108	2444-A	109	2507	65
2290	57	2354	107	2397	108	2445	109	2508	65
2292	58	2355	107	2398	108	2446	109	2550	88
2293	58	2355-A	107	2399	108	2447	109	2551	88
2293-A	58	2356	107	2400	106	2448	109	2552	88
2294	58	2356-A	107	2401	106	2449	109	2553	88
2294-A	58	2358	107	2405	106	2450	109	2554	88
2294-B	58	2359	107	2406	106	2451	110	2555	88
2299	57	2360	107	2406-A	106	2452	110	2556	88
2300	56	2360-A	107	2407	106	2453	110	2557	88
2302	56	2361	107	2412	106	2454	110	2558	88
2304	56	2361-A	107	2413	106	2455	110	2600	89
2319	120	2362	107	2414	106	2456	110	2601	89
2320	120	2363	107	2415	106	2465	110	2602	89
2321	120	2364	107	2416	106	2465-A	110	2603	89
2322	120	2365	107	2417	106	2466	110	2604	89
2323	120	2366	107	2420	108	2466-A	110	2605	89
2324	120	2367	107	2421	108	2467	110	2606	89
2325	120	2368	107	2422	108	2468	110	2607	89
2326	120	2369	107	2423	108	2469	110	2608	89
2327	120	2370	107	2424	108	2470	110	2609	89
2328	120	2371	107	2425	108	2471	110	2610	89
2329	120	2373	107	2426	108	2472	110	2610-A	89
2330	120	2373-A	107	2428	108	2473	110	2611	89
2331	120	2374	107	2429	108	2474	110	2612	89
2332	120	2375	107	2430	109	2475	110	2613	89
2333	120	2376	108	2431	109	2476	119	2614	89
2334	120	2377	108	2432	109	2477	110	2614-A	89
2335	120	2378	108	2433	109	2478	110	2615	89
2336	120	2379	108	2434	109	2479	110	2616	89
2337	120	2387	108	2435	109	2480	110	2617	89
2338	120	2388	108	2436	109	2481	109	2618	89
2339	120	2389	108	2437	109	2482	110	2623	89
2340	120	2390	108	2438	109	2500	65	2624	89
2341	120	2391	57	2439	109	2500-A	65	2625	89

Kod Code	Sayfa Page	Kod Code	Sayfa Page	Kod Code	Sayfa Page	Kod Code	Sayfa Page	Kod Code	Sayfa Page
2626	89	2742	95	2789	93	2855	87	2944	88
2627	89	2743	94	2790	95	2856	87	2945	88
2628	89	2744	94	2791	95	2857	87	2946	88
2629	89	2747	65	2792	95	2858	87	2947	88
2630	89	2748	65	2793	95	2859	87	2948	88
2631	89	2749	65	2795	95	2913	69	2949	88
2700	105	2750	65	2796	94	2914	69	2950	88
2701	105	2751	65	2797	94	2915	69	2951	88
2702	105	2752	65	2798	93	2916	69	2952	88
2703	105	2753	65	2798-A	93	2920	69	2953	88
2704	105	2754	65	2800	111	2921	69	2954	88
2707	105	2755	65	2801	111	2922	69	2955	88
2710	105	2758	95	2802	111	2923	69	2956	88
2711	105	2759	95	2803	111	2924	69	2956-A	88
2712	105	2760	95	2804	111	2925	69	2957	88
2713	105	2761	95	2805	111	2926	69	2957-A	88
2714	105	2762	95	2806	111	2927	69	2967	87
2715	105	2763	93	2807	111	2928	69	2969	65
2720	65	2765	93	2808	111	2929	69	2969-A	65
2721	65	2767	96	2809	111	2930	70	2970	65
2722	65	2768	96	2810	111	2931	70	2970-A	65
2723	65	2769	96	2811	111	2932	70	2971	65
2724	65	2770	96	2812	111	2933	70	2972	65
2725	65	2771	96	2813	111	2934	70	2973	65
2726	65	2772	96	2814	111	2934-A	70	2974	65
2727	65	2773	96	2815	111	2934-B	70	2975	65
2728	65	2773-A	96	2816	111	2934-C	70	2976	65
2729	65	2774	96	2817	111	2935	70	2977	65
2730	65	2775	96	2818	111	2936	70	2978	65
2731	65	2776	95	2819	111	2936-A	70	2980	69
2732	65	2777	95	2820	111	2936-B	70	2981	69
2733	65	2778	95	2821	103	2937	70	2982	69
2734	65	2779	96	2822	103	2938	70	2983	69
2735	65	2780	96	2823	103	2938-A	70	2984	69
2736	65	2781	93	2824	114	2938-B	70	2985	69
2737	65	2782	93	2850	87	2939	70	2986	69
2738	65	2785	93	2851	87	2940	88	2988	69
2739	65	2786	93	2852	87	2941	88	2989	70
2740	95	2787	93	2853	87	2942	88	2990	70
2741	95	2788	93	2854	87	2943	88	2991	70

Kod Code	Sayfa Page	Kod Code	Sayfa Page	Kod Code	Sayfa Page	Kod Code	Sayfa Page	Kod Code	Sayfa Page
3000	66	3042	66	3107	67	3401	91	3451	93
3001	66	3043	66	3108	67	3402	91	3452	93
3002	66	3044	66	3108-A	67	3403	90	3452-A	93
3003	66	3045	66	3109	67	3404	90	3453	93
3004	66	3046	66	3109-A	67	3405	90	3454	93
3005	66	3047	66	3110	67	3405-A	90	3455	93
3006-A	66	3048	66	3111	67	3406	90	3456	93
3007-A	66	3050	66	3112	67	3407	91	3457	93
3008-A	66	3051	66	3113	67	3408	90	3458	93
3009-A	66	3052	66	3114	67	3409	90	3501	82
3010	66	3053	66	3115	67	3410	90	3502	82
3011	66	3054	66	3116	67	3411	90	3503	82
3012	66	3055	66	3117	67	3411-A	90	3504	82
3013	66	3056	66	3118	67	3412	90	3505	82
3014	66	3057	66	3119	67	3412-A	90	3506	82
3015	66	3058	66	3120	67	3413	91	3507	82
3016	66	3059	66	3121	67	3414	91	3508	82
3017	66	3060	67	3122	67	3415	91	3553	82
3020	66	3061	67	3122-A	67	3416	90	3554	82
3021	66	3062	67	3123	67	3417	90	3559	83
3022	66	3063	66	3124	67	3418	90	3560	83
3023	66	3064	66	3125	67	3419	90	3561	83
3024	66	3065	66	3126	67	3420	90	3566	83
3025	66	3066	66	3127	67	3421	90	3567	83
3026	66	3067	66	3128	67	3422	91	3568	83
3027	66	3068	66	3129	67	3423	91	3569	83
3028	66	3073	67	3130	67	3424	91	3570	83
3029	66	3074	67	3133	67	3425	91	3571	83
3030	66	3075	67	3134	67	3426	91	3572	83
3031	66	3076	67	3139	65	3427	91	3573	83
3032	66	3077	67	3140	65	3428	91	3600	84
3033	66	3078	67	3141	65	3429	91	3601	84
3034	66	3100	67	3142	65	3439	90	3602	84
3035	66	3101	67	3143	65	3440	90	3603	84
3036	66	3102	67	3144	65	3441	91	3604	84
3036-A	66	3103	67	3145	65	3442	90	3605	84
3037	66	3104	67	3146	65	3442-A	90	3606	84
3039	66	3105	67	3147	65	3443	90	3608	84
3040	66	3106	67	3148	65	3444	90	3610	84
3041	66	3106-A	67	3400	91	3450	93	3611	85

Kod Code	Sayfa Page	Kod Code	Sayfa Page	Kod Code	Sayfa Page	Kod Code	Sayfa Page	Kod Code	Sayfa Page
3612	85	3680	81	3713-A	72	3750-A	68	3785-B	71
3613	85	3681	81	3714	71	3751	68	3786	71
3614	85	3682	81	3715	72	3751-A	68	3787	72
3615	85	3683	81	3716	72	3753	68	3787-A	72
3616	85	3684	81	3717	72	3753-A	68	3787-B	72
3617	85	3685	81	3718	72	3754	68	3788	72
3618	85	3686	81	3719	72	3755	68	3789	72
3619	85	3687	81	3720	72	3756	68	3790	88
3620	85	3688	81	3721	71	3757	68	3791	88
3622	86	3689	81	3722	72	3758	68	3792	88
3623	86	3690	81	3723	72	3759	68	3793	88
3650	86	3691	81	3724	72	3760	68	3794	88
3650-A	86	3692	81	3725	72	3761	68	3795	88
3651	86	3693	81	3726	72	3762	68	3800	73
3651-A	86	3694	80	3727	72	3766	68	3801	73
3652	86	3695	80	3728	72	3766-A	68	3802	73
3652-A	86	3696	80	3729	72	3767	68	3803	73
3653	86	3697	80	3730	72	3767-A	68	3803-A	73
3653-A	86	3698	80	3731	72	3768	68	3803-B	73
3654	86	3699	80	3732	72	3768-A	68	3804	73
3654-A	86	3700	71	3733	72	3773	68	3805	73
3660	77	3701	71	3734	72	3773-A	68	3806	73
3661	77	3702	71	3735	72	3774	68	3807	73
3662	77	3703	71	3736	72	3774-A	68	3810	73
3663	80	3704	71	3737	72	3775	68	3811	73
3664	79	3705	71	3738	72	3775-A	68	3812	73
3665	78	3706	71	3739	72	3776	68	3813	73
3666	76	3707	71	3740	72	3777	68	3814	73
3667	76	3707-A	71	3741	71	3778	68	3815	73
3668	78	3707-B	71	3742	71	3779	68	3816	75
3670	81	3708	71	3743	71	3780	68	3817	75
3671	81	3708-A	71	3744	71	3781	68	3818	73
3672	81	3708-B	71	3745	71	3782	68	3819	73
3673	81	3709	71	3745-A	71	3782-A	68	3820	75
3674	81	3709-A	71	3746	71	3783	68	3821	75
3675	81	3709-B	71	3747	71	3783-A	68	3823	73
3676	81	3710	71	3748	71	3784	68	3824	73
3677	81	3711	71	3749	71	3784-A	68	3825	73
3678	81	3712	71	3749-A	71	3785	71	3825-A	73
3679	81	3713	72	3750	68	3785-A	71	3826	74

Kod Code	Sayfa Page	Kod Code	Sayfa Page	Kod Code	Sayfa Page	Kod Code	Sayfa Page	Kod Code	Sayfa Page
3827	74	3866	75	3916	75	3950	92	3980	94
3828	74	3867	74	3917	75	3950-A	92	3980-A	94
3829	74	3868	74	3918	76	3950-B	92	3981	94
3830	74	3869	75	3919	79	3951	92	3981-A	94
3831	74	3870	75	3919-A	79	3951-A	92	3982	94
3832	74	3871	75	3920	78	3951-B	92	3982-A	94
3833	74	3872	75	3920-A	78	3952	92	3983	94
3834	74	3873	73	3921-A	77	3952-A	92	3983-A	94
3835	74	3873-A	73	3922	78	3953	92	3984	94
3836	74	3874	73	3923	78	3953-A	92	3984-A	94
3837	74	3875	73	3924	80	3954	92	3985	94
3838	74	3875-A	73	3925	80	3954-A	92	3985-A	94
3839	74	3876	73	3926	80	3955	92	3986	94
3840	74	3876-A	73	3927	79	3955-A	92	3986-A	94
3841	74	3877	75	3927-A	79	3956	92	3987	94
3842	74	3878	75	3928	80	3956-A	92	3987-A	94
3843	74	3879	75	3929	80	3956-B	92	3988	94
3844	74	3880	73	3930	80	3957	92	3988-A	94
3845	74	3880-A	73	3931	80	3957-A	92	3989	94
3846	74	3881	75	3932	80	3957-B	92	3989-A	94
3847	74	3882	75	3933	80	3958	92	3990	76
3848	74	3900	76	3934	80	3958-A	92	3990-A	76
3849	74	3901	76	3935	80	3958-B	92	3990-B	76
3850	74	3902	76	3936	80	3960	92	3991	78
3851	74	3902-A	76	3936-A	80	3960-A	92	3992	76
3852	74	3903	76	3937	79	3960-B	92	3993	77
3853	74	3904	76	3938	79	3961	93	3994	76
3854	74	3905	77	3939	80	3961-A	93	3995	78
3855	74	3906	76	3940	80	3961-B	93	3996	78
3856	74	3906-A	76	3941	80	3962	93	3996-A	78
3857	74	3907	76	3941-A	80	3963	93	3997	78
3858	74	3908	79	3942	80	3964	93	3997-A	78
3859	74	3909	79	3943	80	3964-A	93	3998	78
3860	75	3910	77	3944	80	3964-B	93	4000	87
3861	75	3911	76	3945	79	3973	93	4001	87
3862	75	3912	77	3946	79	3974	81	4002	87
3863	75	3913	77	3947	77	3975	81	4003	87
3864	73	3914	77	3947-A	77	3976	81	4004	87
3864-A	73	3915	79	3948	79	3977	81	4005	87
3865	75	3915-A	79	3949	77	3978	93	4006	87

Kod Code	Sayfa Page	Kod Code	Sayfa Page	Kod Code	Sayfa Page	Kod Code	Sayfa Page	Kod Code	Sayfa Page
4007	87	4190	97	4244	98	4286	100	4334	100
4100	97	4192	97	4245	98	4287	100	4335	100
4101	97	4205	98	4246	98	4289	100	4337	100
4102	97	4206	98	4247	98	4290	100	4338	100
4103	97	4207	98	4248	98	4291	100	4339	100
4104	97	4208	98	4249	98	4292	100	4340	100
4106	97	4209	98	4250	99	4293	100	4341	100
4108	97	4210	98	4251	99	4295	100	4343	101
4110	97	4211	98	4252	99	4296	100	4343-A	101
4113	96	4212	98	4253	99	4297	100	4344	101
4114	96	4213	98	4254	99	4298	100	4345	101
4115	96	4214	98	4255	99	4299	100	4346	101
4116	97	4216	98	4256	99	4301	100	4347	101
4117	97	4217	98	4257	99	4302	100	4348	101
4118	97	4218	98	4258	99	4303	100	4349	101
4119	97	4219	98	4259	99	4304	100	4350	101
4120	97	4220	98	4260	99	4305	100	4351	101
4130	97	4221	98	4261	99	4307	100	4352	101
4131	97	4222	98	4262	99	4308	100	4353	101
4132	97	4223	98	4263	99	4309	100	4354	101
4133	97	4224	98	4264	99	4310	100	4355	101
4134	97	4225	98	4265	99	4311	100	4356	101
4135	97	4226	98	4266	99	4313	100	4357	101
4136	97	4227	98	4267	99	4314	100	4358	101
4140	97	4228	98	4268	99	4315	100	4359	101
4141	97	4229	98	4269	99	4316	100	4360	101
4142	97	4230	98	4270	99	4317	100	4361	101
4143	97	4231	98	4271	100	4319	100	4363	101
4144	97	4232	98	4272	100	4320	100	4364	101
4145	97	4233	98	4273	100	4321	100	4366	101
4146	97	4234	98	4274	100	4322	100	4367	101
4170	97	4235	98	4275	100	4323	100	4369	101
4171	97	4236	98	4277	100	4325	100	4370	101
4172	97	4237	98	4278	100	4326	100	4371	101
4173	97	4238	98	4279	100	4327	100	4372	99
4174	97	4239	98	4280	100	4328	100	4372-A	99
4178	97	4240	98	4281	100	4329	100	4395	101
4179	97	4241	98	4283	100	4331	100	04751	50
4182	97	4242	98	4284	100	4332	100	04752	50
4183	97	4243	98	4285	100	4333	100	04753	51

Kod Code	Sayfa Page	Kod Code	Sayfa Page	Kod Code	Sayfa Page	Kod Code	Sayfa Page	Kod Code	Sayfa Page
04754	51	5025-1200	11	5120-1450	11	05753	51	7504	124
04755	51	5025-1480	11	5120-1720	11	05753-A	51	8022	144
04851	54	5025-1750	11	5120-1970	11	05754	51	8050	89
04851-A	54	5025-2000	11	5121-1170	11	05754-A	51	8051	89
04852	54	5030-1000	12	5121-1450	11	05755	51	8052	89
04852-A	54	5030-1200	12	5121-1720	11	05755-A	51	8053	89
04853	54	5030-400	12	5121-1970	11	6000	122	8054	89
04853-A	54	5030-500	12	5122-1170	11	6013	122	8080	144
5005-1500	7	5030-600	12	5122-1450	11	6050	88	8081	144
5005-2000	7	5030-700	12	5122-1720	11	6050-A	88	8083	102
5005-2500	7	5030-800	12	5122-1970	11	6051	88	8084	102
5006-1500	7	5030-900	12	5130-1000	12	6052	88	8086	102
5006-2000	7	5035-1000	13	5130-1200	12	6053	88	8087	102
5006-2500	7	5035-1200	13	5130-1500	12	6054	88	8088	102
5009-1000	7	5035-600	13	5130-2000	12	6054-A	88	8089	102
5009-1200	7	5035-800	13	5140-1000	13	7013	122	8091	101
5009-1480	7	5040-900	14	5140-1200	13	7014	122	8092-A	101
5009-1750	7	5045-1000	15	5140-1500	13	7015	122	8093	69
5009-2000	7	5045-680	15	5140-2000	13	7016	122	8094	69
5009-400	7	5045-880	15	5150-1160	14	7026	122	8095	69
5009-500	7	5050-1000	16	5150-1346	14	7200	124	8096	69
5009-600	7	5050-1200	16	5150-1762	14	7201	124	8097	69
5009-750	7	5050-1500	16	5160-600	15	7204	124	8098	102
5009-850	7	5050-800	16	5160-800	15	7205	124	21100	106
5009-940	7	5055-1020	17	5160-920	15	7206	124	21104	106
5015-1000	6	5055-460	17	5170-1160	16	7207	124	21108	106
5015-1200	6	5055-860	17	5170-1460	16	7250	124	21109	106
5015-1480	6	5101-1000	6	5170-760	16	7251	124	21110	106
5015-1750	6	5101-1200	6	5170-960	16	7252	124	21117	119
5015-2000	6	5101-1500	6	5190-390	17	7304	123	21123	106
5015-400	6	5101-2000	6	5191-750	17	7305	123	21132	106
5015-500	6	5101-2000	11	5191-910	17	7306	123	21303	119
5015-600	6	5101-2000	9	5200-700x1200	18	7307	123	21304	119
5015-750	6	5110-2000	11	5200-700x2400	18	7400	123	21306	119
5015-850	6	5110-2000	9	5201-1050x1200	18	7401	123	21313	119
5015-940	6	5111-2000	9	5201-1050x2400	18	7402	123	21314	119
5020-1200	9	5111-2000	11	05751	50	7403	123	21316	119
5020-1480	9	5112-2000	9	05751-A	50	7406	123	22400	103
5020-1750	9	5112-2000	11	05752	50	7502	124	22401	103
5020-2000	9	5120-1170	11	05752-A	50	7503	124	22403	103

Kod Code	Sayfa Page	Kod Code	Sayfa Page	Kod Code	Sayfa Page	Kod Code	Sayfa Page	Kod Code	Sayfa Page
22406	103	22564	103	22713	104	23018	103	27301	112
22407	103	22580	103	22750	104	23019	103	27303	112
22408	103	22581	103	22751	104	23020	103	27304	112
22409	103	22582	103	22755	104	23021	103	27305	112
22410	103	22590	103	22756	104	23022	103	27306	112
22411	103	22591	103	22757	104	23023	103	27307	112
22412	103	22592	103	22757-A	104	23026	104	27308	112
22450	103	22600	104	22758	104	23050	105	27309	112
22451	103	22601	104	22759	104	23051	105	27310	112
22453	103	22605	104	22760	104	23054	105	27311	112
22456	103	22606	104	22761	104	23055	105	27312	112
22457	103	22607	104	22761-A	104	23056	105	27313	113
22458	103	22608	104	22762	104	23057	105	27314	113
22459	103	22609	104	22763	104	23058	105	27316	112
22460	103	22610	104	22764	104	23059	105	27317	112
22461	103	22611	104	22770	104	23062	103	27318	112
22462	103	22612	104	22771	104	23066	103	27319	112
22500	103	22613	104	22772	104	23067	103	27320	112
22501	103	22650	104	22777	104	23072	104	27321	112
22501-A	103	22651	104	22778	104	23073	104	27323	112
22503	103	22655	104	22779	104	23076	103	27325	112
22506	103	22656	104	22780	104	23077	103	27326	112
22507	103	22657	104	22809	105	23082	104	27327	112
22508	103	22658	104	22815	105	23083	104	28402	113
22509	103	22659	104	22900	103	23092	104	28403	113
22510	103	22660	104	22900-A	103	23093	104	28404	114
22511	103	22661	104	22900-B	103	23094	104	28404-A	114
22512	103	22662	104	22901	103	26106	121	28405	114
22550	103	22663	104	22902	103	26106-B	121	28405-A	114
22551	103	22700	104	22902-A	103	26107	121	28406	115
22551-A	103	22701	104	22905	105	26200	121	28411	117
22553	103	22705	104	22906	105	26200-A	121	28412	117
22556	103	22706	104	22908	105	26202	121	28413	117
22557	103	22707	104	22909	105	26202-A	121	28414	117
22558	103	22708	104	22911	105	26300	121	28417	118
22559	103	22708-A	104	22915	105	26301	121	28418	118
22560	103	22709	104	23000	105	26302	121	28419	118
22561	103	22710	104	23001	105	26303	121	28420	118
22562	103	22711	104	23002	105	26303-A	121	28421	118
22563	103	22712	104	23003	105	27300	112	28422	118

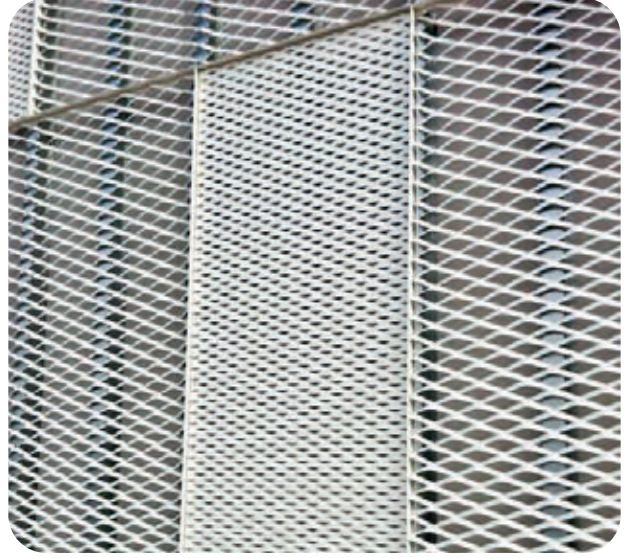

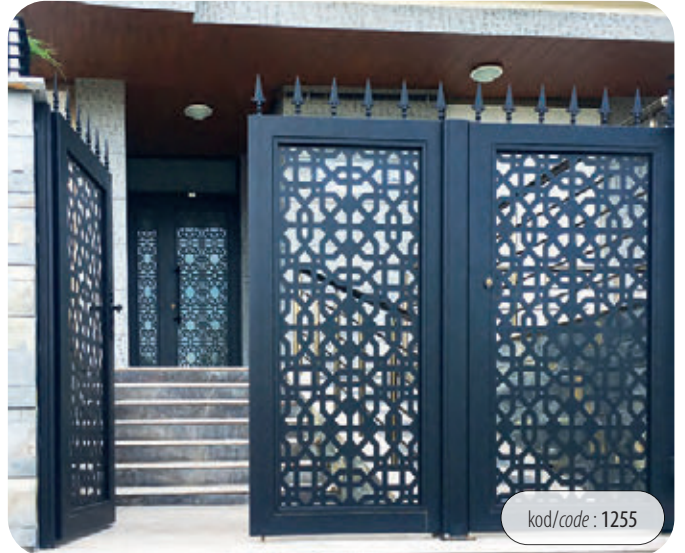
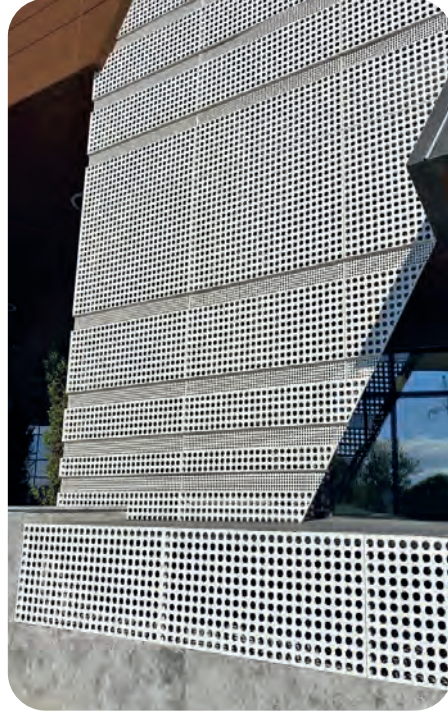
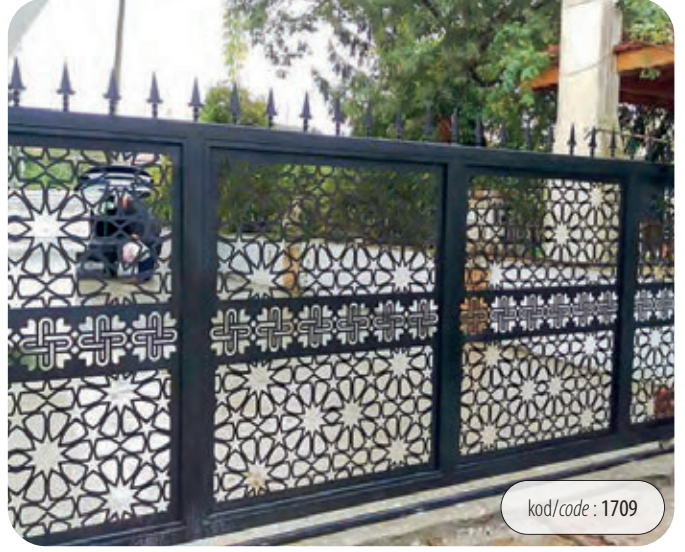
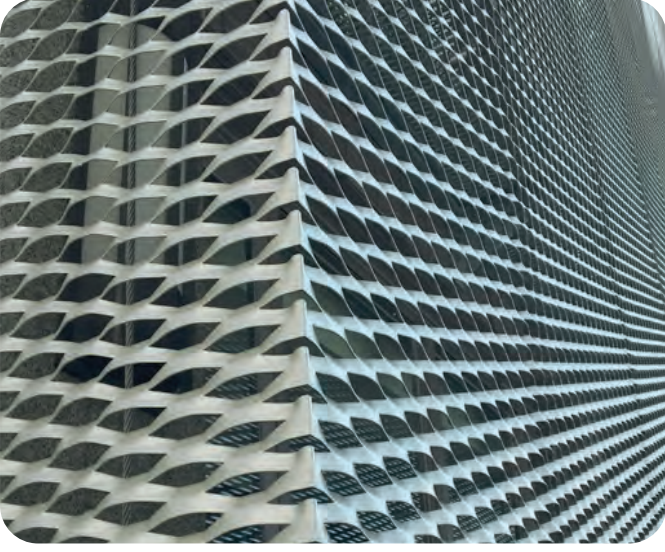

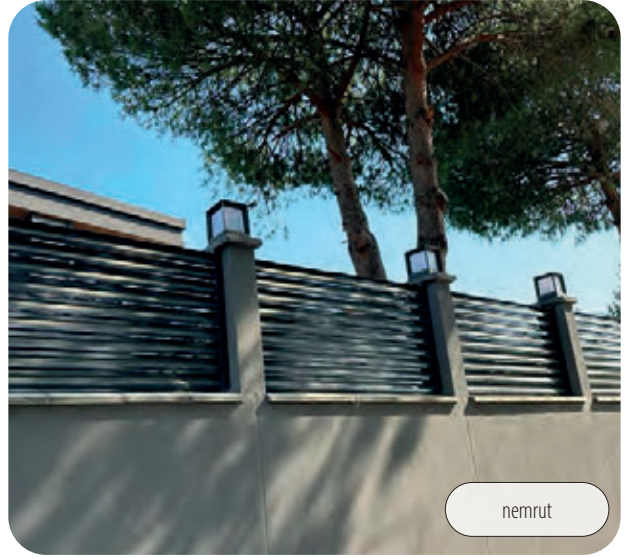

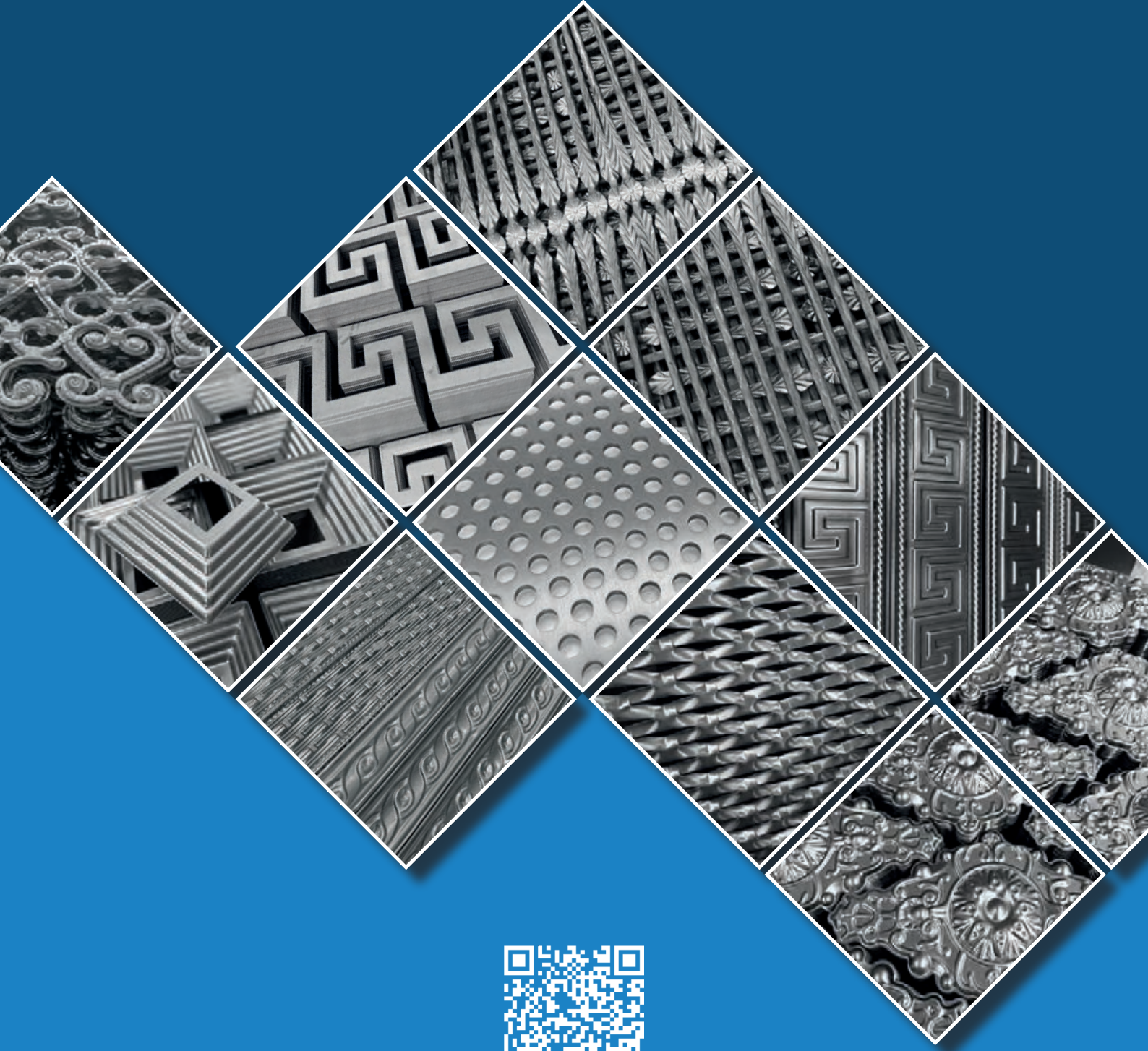

www.kirimcimetal.com



KIRIMCI
METAL

KIRIMCI METAL FORM
SAN. ve TİC. AŞ.

Hasanağa Organize Sanayi Bölgesi
8. Cadde No.1 Nilüfer / Bursa / TURKEY

t. +90 224 482 26 02
t. +90 224 482 26 07

+90 531 624 65 88 (Export)
+90 534 088 74 98 (Yurtiçi Satış)

info@kirimcimetal.com
www.kirimcimetal.com